

# AEROSPRAY<sup>®</sup> HEMATOLOGY STAT

MODEL 7122



## Applications Manual

SLIDE STAINER/CYTOCENTRIFUGE

# **AEROSPRAY® HEMATOLOGY STAT**

SLIDE  
STAINER/CYTOCENTRIFUGE

Model 7122

## **Applications Manual**

57-2000-02D



Last Revision 02/10/2023

©2023 ELITechGroup Inc. All rights reserved. Printed in the United States of America. No part of this publication may be reproduced, transmitted, transcribed, stored in a retrieval system, or translated into any language (human or computer) in any form, or by any means whatsoever, without the prior express written permission of ELITechGroup Inc.

Aerospray®, Cytopro® are trademarks of ELITechGroup Inc.

Other trade names used in this manual are trademarks of their respective owners, used here for information only.

ELITechGroup Inc. makes no express or implied warranty regarding this manual, its quality, performance, or appropriate use regarding any type of specific procedure. ELITechGroup Inc. may modify this manual without notice and without implying any obligation or liability on the part of the company.

Manufactured in the United States of America by:



**ELITechGroup Inc.**  
370 West 1700 South  
Logan, Utah 84321 USA



## Table of Contents

### Section 1

#### Introduction

1.1 Instrument Overview .....	7
Using this Manual .....	7
Functional Description .....	8
Key Features .....	9
Intended Use .....	9
<i>Table 1: General Specifications</i> .....	10
<i>Table 2: Performance Specifications</i> .....	11
<i>Table 3: Run Time Sequence</i> .....	12
<i>Table 4: Approximate Reagent Consumption</i> .....	12
<i>Table 5: Carousel and Rotor Information</i> .....	13
<i>Table 6: Explanation of Symbols</i> .....	14
1.2 Instrument Description .....	17
<i>Figure 1: Front and Right-Side Panels</i> .....	17
<i>Figure 2: Front Panel and Touchscreen</i> .....	18
<i>Figure 3: Rear Panel</i> .....	18
<i>Figure 4: Stainer Bowl Components</i> .....	19
<i>Figure 5: Nozzle Diagram</i> .....	19
<i>Table 7: Preventive Maintenance Kit</i> .....	20
Barcode Reader .....	21
<i>Figure 6: Barcode Reader</i> .....	21
1.3 Touchscreen and User Interface .....	22
<i>Table 8: Front Panel/Main Screen Function Keys</i> .....	22
<i>Table 9: System Setup Keys</i> .....	23
<i>Table 10: Maintenance Function Keys</i> .....	25

### Section 2

#### Setup and Preparation for Operation

2.1 Instrument Setup .....	26
Unpacking and Installing the Stainer .....	26
Connecting the Drain Tube and Waste Container .....	27
Connecting Power .....	27
Installing Reagent Bottles .....	28
Installing the Barcode Reader .....	29
2.2 Preparing the Stainer for Operation .....	30
Priming Procedures .....	30
The Clean Cycle .....	32
Performing Tests .....	32
Reagent Level Monitoring .....	33
<i>Enabling/Disabling Reagent Level Detect</i> .....	33
<i>Zeroing the Reagent Level Sensors</i> .....	34

### Section 3

#### Controlling and Customizing Stainer Functions

3.1 System Setup Menu .....	36
Accessing the System Setup Menu .....	36
Stain Programs .....	36
Creating a Stain Program .....	37
Editing, Renaming, or Adjusting Stain Programs .....	37
Administrator and User Accounts .....	38
<i>Creating an Administrator Account</i> .....	38

## Table of Contents

### Section 3

#### Controlling and Customizing Stainer Functions (continued)

<i>Creating User Accounts</i> .....	39
<i>Managing User Access</i> .....	40
<i>User Login/Logout</i> .....	40
Using Reagent Information Tracking .....	42
Modifying Level Detect Functions .....	42
Changing User Language .....	43
Setting the Date and Time .....	43
System Log .....	43
<i>Accessing Logs</i> .....	43
<i>Exporting Logs</i> .....	44
Controlling Beeper Alerts .....	44
QC/Maintenance Tracking .....	45
<i>Enable Stain Slide Tracking</i> .....	45
<i>Enable Cyto Slide Tracking</i> .....	46
<i>Enable Manual Entry</i> .....	46
<i>Enable Preventive Maintenance Tracking</i> .....	46
<i>Enable Reagent Tracking</i> .....	46
Restoring Software Defaults .....	47
3.2 Recording Specimen and Reagent Information .....	48
Scanning Slides with the Barcode Reader .....	48
Scanning Reagent Bottles with the Barcode Reader .....	49
Manually Entering Specimen information .....	50
Manually Entering Reagent Information .....	51
3.3 The Help Menu .....	52
Using Help .....	52

### Section 4

#### Operating the Stainer

4.1 Operating Instructions .....	53
Suggested Staining Protocol .....	53
Performing a Hub Pattern Test .....	53
<i>Figure 7: Correct Hub Pattern Test Result</i> .....	53
<i>Figure 8: Incorrect Hub Pattern Test Result</i> .....	53
Loading the Carousel .....	54
<i>Figure 9: Loading the Carousel</i> .....	55
<i>Figure 10: Specimen Placement on Slide</i> .....	55
Using Blocking Slides .....	56
<i>Figure 11: Using Blocking Slides</i> .....	56
Performing a Stain Cycle .....	56
Unloading the Carousel .....	57
Monitoring Reagent and Waste Levels .....	58
<i>Table 11: Reagent Level Detect Display Symbols</i> .....	58
Replacing a Reagent Bottle .....	59
Emptying the Waste Container .....	59

### Section 5

#### Preventive Maintenance and Safety

5.1 Preventive Maintenance .....	60
Daily Maintenance/Quality Control (QC) .....	60
Weekly Maintenance .....	60
Monthly Maintenance .....	61
Using the Preventive Maintenance Log .....	61

## Table of Contents

### Section 5

#### Preventive Maintenance and Safety (continued)

5.2 Storing the Instrument .....	62
Preparing for Long-Term Storage .....	62
5.3 Replacing Fuses .....	63
5.4 Cleaning the Stainer and Carousels .....	64
Cleaning Liquid Spills .....	64
Cleaning Broken Slides .....	64
5.5 Decontaminating the Stainer and Carousels .....	65
Solutions for Decontaminating the Instrument.....	65
<i>Figure 12: Lid Latch and Locking Pin Hole Locations</i> ....	66
Decontaminating the Instrument.....	66
Decontaminating Reagent Bottles.....	67
5.6 Shipping or Disposing of the Stainer or Carousels.....	68
Shipping the Instrument or Carousels.....	68
<i>Hazard-Free Certification</i> .....	68
Disposing of the Instrument or Carousels .....	68

### Section 6

#### Nozzle Maintenance and Performance

6.1 Nozzle Disassembly and Cleaning.....	69
Nozzle Disassembly .....	69
Nozzle Cleaning .....	69
6.2 Nozzle Reassembly .....	70
6.3 Manual Priming .....	71
6.4 Performing the Volume Test .....	72
<i>Table 12: Volume Test Tolerances</i> .....	72
6.5 Performing the Slide Pattern Test .....	74
<i>Figure 13: Correct Slide Pattern Test Result</i> .....	74
<i>Figure 14: Incorrect Slide Pattern Test Result</i> .....	74

### Section 7

#### Solving Problems

7.1 Troubleshooting .....	75
<i>Table 13: General Troubleshooting and Diagnosis</i> .....	75
7.2 Abnormal Staining Results .....	81
Smear Separation or Tearing.....	81
<i>Improper Alcohol Fixation</i> .....	81
<i>Wet Smears</i> .....	81
<i>Thick Smears</i> .....	81
<i>Dirty Slides</i> .....	81
<i>Red Cell Artifacts</i> .....	81
<i>Use Aerofix®</i> .....	82
<i>False-Positive Howell-Jolley Bodies or Amorphous         Precipitates</i> .....	82
7.3 Instrument Malfunction .....	84
Air or Reagent Leaks.....	84
Reagent Level Detect System Errors .....	85
Calibrating the Reagent Level Detect System.....	85
7.4 Calibrating the Touchscreen.....	87
7.5 Service Information .....	88

## Table of Contents

### Section 8

#### Cytopro® Cytocentrifuge

8.1 Cytopro Cytocentrifuge Information .....	89
Functional Description .....	89
Key Features .....	89
Cytopro® Rotor .....	89
<b>Appendix A: Critical Reagent Components .....</b>	<b>90</b>
<b>Appendix B: Stain Information .....</b>	<b>92</b>
<b>Appendix C: Accessories and Supplies .....</b>	<b>93</b>
<b>Appendix D: Cleaning Solutions .....</b>	<b>94</b>

# SECTION 1 INTRODUCTION

## 1.1 Instrument Overview

### Using this Manual

This manual provides instructions to install, operate, and maintain the Aerospray Hematology Stat Stainer/Cytocentrifuge. The manual is an important part of the product. Read it carefully and completely before setup and first use of the instrument.

If additional accident prevention and environmental protection requirements exist in the country of operation, this manual must be supplemented by appropriate instructions to ensure compliance.

### Safety Regulations

This instrument has been built and tested in accordance with safety regulations for the following device types: electrical control, regulating, and laboratory. In order to maintain this condition and ensure safe operation, the operator must observe all the instructions and warnings contained in this manual. For current information about applicable standards, please refer to the CE Declaration of Conformity included with the documents shipped with this device.

**NOTE:** *This equipment complies with the emission and immunity requirements described in the IEC 61326 series.*

### Understanding Warnings

This manual uses three warning levels to alert you to important information as shown in the following examples.

#### WARNING!



**A Warning alerts to the possibility of personal injury, death, or other serious adverse reactions stemming from the use or misuse of this device or its components.**



#### CAUTION:

A Caution alerts to possible problems with the device associated with its use or misuse. Such problems include device malfunction, failure, damage, damage to the sample, or damage to other property. Where applicable, a Caution may include precautions to be taken to avoid the hazard.

**NOTE:** *A Note reinforces or supplies additional information about a topic.*

### Specific Warnings

Pay particular attention to the following safety precautions. If these safety precautions are ignored, injury or damage to the instrument may occur. Each individual precaution is important.



#### WARNING!

**Install the stainer in a well-ventilated area. If ventilation is inadequate, operate the instrument under a safety hood.**



## SECTION 1 INTRODUCTION

### **1.1 Instrument Overview**



**WARNING!**

Reagents used in the stainer contain moderately hazardous chemicals that require care in handling. Always use appropriate safety measures including gloves and eye protection when handling reagents.



**WARNING!**

Always wear protective clothing and eye protection when using Nozzle Cleaning Solution (diluted SS-029C) and Stain Residue Solvent (SS-230). Dispose of used solution properly.



**WARNING!**

If power is lost while the stainer is running, the lid will remain locked until power is restored. Do not attempt to open the lid while power is off.



**WARNING!**

Electrical shock hazard: Do not open this instrument or attempt internal repairs. Refer servicing to qualified service personnel. Contact ELITechGroup Biomedical Systems service.



**CAUTION:**

This equipment has been designed and tested to CISPR 11 Class A and FCC Part 15 Class A. In a domestic environment it may cause radio interference, in which case, you may need to take measures to mitigate the interference.



**CAUTION:**

To avoid serious instrument damage, always use reagents supplied by ELITechGroup. Using reagents not supplied by ELITechGroup may void the warranty.



**CAUTION:**

Only spare parts supplied or specified by ELITechGroup should be used in this instrument. Using non-approved parts may affect the performance and safety features of the instrument. If the instrument is used in a manner not specified by ELITechGroup the protection provided by the instrument may be impaired. If in doubt, contact your ELITechGroup representative.

### **Functional Description**

The Aerospray Hematology Stat Slide Stainer/Cytocentrifuge (Model 7122) is a dual-purpose, microprocessor-controlled slide staining and cell preparation system. In use, atomizing spray nozzles apply fresh reagents onto microscope slides prepared with blood or other body fluid specimens. The slides are mounted in a rotating carousel for processing.

## SECTION 1 INTRODUCTION

### ***1.1 Instrument Overview***

#### **Key Features**

- Minimized reagent consumption
- Rapid staining
- Barcode scanner for tracking specimens and reagents
- Reagent and specimen traceability
- User traceability
- Administrator password
- Interactive touchscreen display
- Multiple languages
- High-volume staining productivity (12 slides per stain cycle)
- Separate reservoir, delivery tube, pump, and spray nozzle for each reagent
- Operator-selectable automatic alcohol fixation function to fix specimens
- Reagent and waste level monitoring
- Log files
- 10 Stain intensity settings

The correct accessory must be used for each function. The Cytopro® Cytocentrifuge Rotor is available as an option offering additional features (see Section 8).

#### **Intended Use**

The Aerospray Hematology Stat Slide Stainer/Cytocentrifuge (Model 7122) is intended for use by medical professionals to stain specimens that may include blood and other body fluids, as a step of standard laboratory practice in diagnosing disease. Addition of the Cytopro rotor allows preparation of slides by cytocentrifugation before staining.

SECTION 1  
INTRODUCTION

**1.1 Instrument Overview**

**Table 1: General Specifications**

<b>Category</b>	<b>Characteristics</b>
Slide Carousel Capacity	1 to 12
Carousel Rotation Speed	From 10 to 1000 rpm (pre-programmed) 10 rpm to 99 rpm $\pm$ 2rpm, 100 rpm to 1000 rpm $\pm$ 5%
Cytocentrifuge Rotor Speed	100 to 2000 rpm ( $\pm$ 5%), user programmable
Reagent Consumption	Refer to Approximate Reagent Consumption, Table 4
Operating Time	Refer to Run Time Sequence, Table 3
Display	7 in. LCD, WVGA (800 x 480 pixels) TFT
Touchscreen Controls	Numeric and alpha-numeric programming keys
Drain Connection	Connector on rear panel accepts male connector attached to 3/8 in ID vinyl drain tube. 1.8 meters (6 ft.) length supplied
Ventilation	Air is exhausted from the stainer via a female ½ inch SAE pipe thread fitting to allow connection to ventilation systems
Dimensions Width Height (lid closed) Depth Height (lid open)	57 cm (22 in.) 25 cm (10 in.) 54 cm (21 in.) 58 cm (23 in.)
Weight	~16.3 kg (~35.9 lb.) – unpacked ~21.4 kg (~47.2 lb) – packed
Electrical Requirements	100 to 240 VAC ( $\pm$ 10%) @ 50 to 60 Hz
Power Consumption	200 VA
Fuses	Fuses (quantity 2): T2A250V~
Ambient Temperature Operating Storage	15 to 30 °C (59 to 86 °F) -10 to 50 °C (14 to 122 °F)
Relative Humidity	$\leq$ 80% non-condensing
Altitude	$\leq$ 2000 m ( $\leq$ 6562 ft.)

SECTION 1  
INTRODUCTION

**1.1 Instrument Overview**

**Table 1: General Specifications (continued)**

Category	Characteristics
Pollution Degree	2
Heat Dissipation Maximum Average During Staining Average While Idle	150 Watts (512 Btu/hour) 30 Watts (102 Btu/hour) 12 Watts (41 Btu/hour)
Maximum Sound Emission	Adjustable: maximum 60 dB (SPL intensity at 1 m and <80 dB: typically 72 dB

**Table 2: Performance Specifications**

Category	Characteristics
Reagent Spray Nozzles	Four reagent nozzles: A, B, C, D
Reagents:	A - Rinse
<p><b>NOTE:</b> Use only ELITechGroup reagents, with diluents as specified for ELITechGroup concentrated reagents. REF numbers for this stainer start with one of the following: SS-035, SS-049, SS-135, SS-149, SS-048, or SS-148.</p>	B – Thiazin Stain (Blue)
	C – Eosin Stain (Red)
	D – Methanol or Aerofix®
	<b>Note:</b> Methanol must be 99.5% pure no more than 0.5% water.
Stain Settings	Number of slides to stain. Intensity settings: 1-10. Fixation level: Off, Normal, High

SECTION 1  
INTRODUCTION

**1.1 Instrument Overview**

**Table 3: Run Time Sequence**

**NOTE:** Table 3 represents a typical timing sequence for this instrument using the 12-slide carousel, presented for general reference only. Timing is in seconds. Actual cycle times may vary.

Staining Mode	Medium Dark Setting (5)
Fixation Pump D (Optional)	(102)
Eosin Stain (Pump C)	21
Thiazin Stain (Pump B)	33
Rinse (Pump A)	27
High Speed Dry	33
Total without fixation (in minutes)	<b>1.9</b>
Total with fixation (in minutes)	<b>3.6</b>

**Table 4: Approximate Reagent Consumption (mL)**

Staining Mode	Medium Dark Setting (5)	Clean Cycle
Reagent A: Rinse	6.0	7.5
Reagent B: Thiazin	6.0	7.5
Reagent C: Eosin	6.0	7.5
Reagent D: Fixative	1.4	38.0

SECTION 1  
INTRODUCTION

**1.1 Instrument Overview**

**Table 5: Carousel and Rotor Information**

Only the following slide staining carousel or cytocentrifuge rotor can be used in this instrument. Each should be used following the instructions in this manual or the Cytopro Applications Manual (RP-517).











<b>Rotor/Carousel</b>	<b>Maximum rpm</b>	<b>Maximum Capacity</b>	<b>Maximum Sample Volume</b>
12-Slide Carousel (AC-188)	1000 rpm	12 each, 26 mm x 76 mm (1 x 3 inch) microscope slides	N/A
Cytopro Cytocentrifuge Rotor (AC-160)	2000 rpm	8 each, standard chambers, plus slides	Up to 600 $\mu$ L*
		8 each, Cytopro Magnum chambers, plus slides	Up to 6 mL*















\*Do not overfill cytocentrifuge chambers. See Cytopro Applications Manual or Methods Manual for detailed instructions and warnings.

# SECTION 1 INTRODUCTION











## 1.1 Instrument Overview

**Table 6: Explanation of Symbols**

SYMBOL	STANDARD REFERENCE	STANDARD TITLE	SYMBOL TITLE	SYMBOL MEANING
	IEC 60601- 1 Reference no. Table D1, Symbol 8 (IEC 60417-5032)	Medical electrical equipment — Part 1: General requirements. for basic safety and essential performance	Alternating current	To indicate on the rating plate that the equipment is suitable for alternating current only; to identify relevant terminals
	ISO 15223-1: 2021 Reference no. 5.1.2	Medical devices — Symbols to be used with information to be supplied by the manufacturer - Part 1: General requirements.	Authorized Representative in the European Community/ European Union	Indicates the authorized representative in the European Community / European Union
	MU600_00_016e V3.0	Information Sheet Obligations Economic Operators CH	Swiss Authorized Representative	Indicates the authorized representative in Switzerland
	ISO 15223-1: 2021 Reference no. 5.1.5. (ISO 7000-2492)	Medical devices — Symbols to be used with information to be supplied by the manufacturer - Part 1: General requirements.	Batch code	Indicates the manufacturer's batch code so that the batch or lot can be identified. Synonyms for "batch code" are "lot number", "lot code" and "batch number".
	ISO 15223-1:2021 reference no. 5.4.1 (ISO 7010 – W009)	Medical devices — Symbols to be used with information to be supplied by the manufacturer - Part 1: General requirements.	Warning; Biological hazard	Bio-contamination warning: Use care when operating upper cooling system and initiation needle.
	ISO 15223-1: 2021 Reference no. 5.1.6. (ISO 7000-2493)	Medical devices — Symbols to be used with information to be supplied by the manufacturer - Part 1: General requirements.	Catalogue number Catalog number	Indicates the manufacturer's catalog number so that the medical device can be identified ISO 15223 Catalogue number ISO 7000 Catalog number
	ISO 15223-1: 2021 Reference no. 5.4.4. (ISO 7000-0434A)	Medical devices — Symbols to be used with information to be supplied by the manufacturer - Part 1: General requirements.	Caution	To indicate that caution is necessary when operating the device or control close to where the symbol is placed, or to indicate that the current situation needs operator awareness or operator action in order to avoid undesirable consequences
	EU 2017-746 Reference no. ANNEX V	REGULATION (EU) 2017/746 OF THE EUROPEAN PARLIAMENT AND OF THE COUNCIL of 5 April 2017 on in vitro diagnostic medical devices and repealing Directive 98/79/ EEC and 2010/227/EU	CE marking	(43) 'CE marking of conformity' or 'CE marking' means a marking by which a manufacturer indicates that a device is in conformity with the applicable requirements set out in this Regulation and other applicable Union harmonization legislation providing for its affixing
	ISO 15223-1:2021 Reference no. 5.4.3. (ISO 7000-1641)	Medical devices — Symbols to be used with information to be supplied by the manufacturer - Part 1: General requirements.	Consult instructions for use or consult electronic instructions for use	Indicates the need for the user to consult the instructions for use
	ISO 15223-1:2021 Reference no. 5.4.2. (ISO 7000- 1051)	Medical devices — Symbols to be used with information to be supplied by the manufacturer - Part 1: General requirements.	Do not re-use	Indicates a medical device that is intended for one single use only NOTE: Synonyms for "Do not reuse" are "single use" and "use only once".

SYMBOL	STANDARD REFERENCE	STANDARD TITLE	SYMBOL TITLE	SYMBOL MEANING
	ISO 15223-1: 2021 Reference no. 5.2.8. (ISO 7000-2606)	Medical devices — Symbols to be used with information to be supplied by the manufacturer - Part 1: General requirements.	Do not use if package is damaged and consult instructions for use	Indicates a medical device that should not be used if the package has been damaged or opened and that the user should consult the instructions for use for additional information
	ISO 15223-1: 2021 Reference no. 5.3.1. (ISO 7000-0621)	Medical devices — Symbols to be used with information to be supplied by the manufacturer - Part 1: General requirements.	Fragile, handle with care	Indicates a medical device that can be broken or damaged if not handled carefully
	IEC 60417-1 Reference no. ISO 7000-5016	Graphical symbols for use on equipment	Fuse	To identify fuse boxes or their location
	IEC-TR-60878 Reference no. ISO 7000-1135	Graphic symbols for use on electrical equipment in a medical practice	General symbol for recover/recyclable	To indicate that the marked item or its material is part of a recovery or recycling process
	ISO 15223-1:2021 Reference no. 5.5.1.	Medical devices — Symbols to be used with information to be supplied by the manufacturer - Part 1: General requirements.	In Vitro diagnostic medical device	Indicates a medical device that is intended to be used as an in vitro diagnostic medical device
	ISO 15223-1: 2021 Reference no. 5.3.2. (ISO 7000-0624)	Medical devices — Symbols to be used with information to be supplied by the manufacturer - Part 1: General requirements.	Keep away from sunlight	Indicates a medical device that needs protection from light sources
	ISO 15223-1: 2021 Reference no. 5.1.1. (ISO 7000-3082)	Medical devices — Symbols to be used with information to be supplied by the manufacturer - Part 1: General requirements.	Manufacturer	Indicates the medical device manufacturer
	DIRECTIVE 2012/19/EU (WEEE)	N/A	Collect separately	Separate collection for waste of electrical and electronic equipment. Do not dispose of battery in municipal waste. The symbol indicates separate collection for battery is required
	Directive 2002/96/EC (WEEE)	N/A	Collect separately	Separate collection for waste of electrical and electronic equipment. Do not dispose of battery in municipal waste. The symbol indicates separate collection for battery is required
	N/A	N/A	Open bottle stability	Indicates a reagent is stable after opening for the number of months specified
	ISO 15223-1: 2021 Reference no. 5.1.7. (ISO 7000-2498)	Medical devices — Symbols to be used with information to be supplied by the manufacturer - Part 1: General requirements.	Serial number	Indicates the manufacturer's serial number so that a specific medical device can be identified
	ISO 15223-1: 2021 Reference no. 5.3.7. (ISO 7000-0632)	Medical devices — Symbols to be used with information to be supplied by the manufacturer - Part 1: General requirements.	Temperature limit	Indicates the temperature limits to which the medical device can be safely exposed
	ISO 15223-1: 2021 Reference no. 5.1.4. (ISO 7000-2607)	Medical devices — Symbols to be used with information to be supplied by the manufacturer - Part 1: General requirements.	Use by date	Indicates the date after which the medical device is not to be used
	iso_grs_7010_WOO1	Medical devices — Symbols to be used with information to be supplied by the manufacturer - Part 1: General requirements.	General warning sign	To signify a general warning
	GHS02	Globally Harmonized System of Classification and Labeling of Chemicals (GHS), Eighth Revised Edition	flammable	Medical device contains materials that are flammable. Appropriate caution should be taken



SYMBOL	STANDARD REFERENCE	STANDARD TITLE	SYMBOL TITLE	SYMBOL MEANING
	GHS03	Globally Harmonized System of Classification and Labeling of Chemicals (GHS), Eighth Revised Edition	Oxidizing	Medical device contains materials that are oxidizing. Appropriate caution should be taken
	GHS05	Globally Harmonized System of Classification and Labeling of Chemicals (GHS), Eighth Revised Edition	Corrosive	Medical device contains materials that are corrosive. Appropriate caution should be taken
	GHS06	Globally Harmonized System of Classification and Labeling of Chemicals (GHS), Eighth Revised Edition	Toxic	Medical device contains materials that are toxic. Appropriate caution should be taken
	GHS07	Globally Harmonized System of Classification and Labeling of Chemicals (GHS), Eighth Revised Edition	Harmful	Medical device contains materials that are harmful. Appropriate caution should be taken
	GHS08	Globally Harmonized System of Classification and Labeling of Chemicals (GHS), Eighth Revised Edition	Health Hazard	Medical device contains materials that are a health hazard. Appropriate caution should be taken
	GHS09	Globally Harmonized System of Classification and Labeling of Chemicals (GHS), Eighth Revised Edition	Environmental Hazard	Medical device contains materials that are an environmental hazard. Appropriate caution should be taken
	N/A	Administrative Measure on the Control of Pollution Caused by Electronic Information Products (China)	Environment Friendly Use Period	Indicates the period of time before any RoHS substances are likely to leak out causing harm to the environment.
	N/A	N/A	Do not use pumps	Indicates products are to be used for manual cleaning only. Do not pump the product through instrument.
	ISO 15223-1: 2021 Reference no. 5.1.6. (ISO 7000-2493)	Medical devices — Symbols to be used with information to be supplied by the manufacturer - Part 1: General requirements.	Catalogue number Catalog number	Indicates the manufacturer's catalog number so that the medical device can be identified ISO 15223 Catalogue number ISO 7000 Catalog number
	ISO 15223-1: 2021 Reference no. 5.3.8. (ISO 7000-2620)	Medical devices — Symbols to be used with information to be supplied by the manufacturer - Part 1: General requirements.	Humidity limitation	Indicates the range of humidity t which the medical device can be safely exposed
	N/A	<a href="https://www.gov.uk/guidance/using-the-ukca-marking#when-to-use-the-ukca-marking">https://www.gov.uk/guidance/using-the-ukca-marking#when-to-use-the-ukca-marking</a>	UKCA Mark	UK product marking that is required for medical devices being placed on the marketing in Great Britain.

SECTION 1  
INTRODUCTION

**1.2 Instrument Description**

**Figure 1: Front and Right Side Panels**

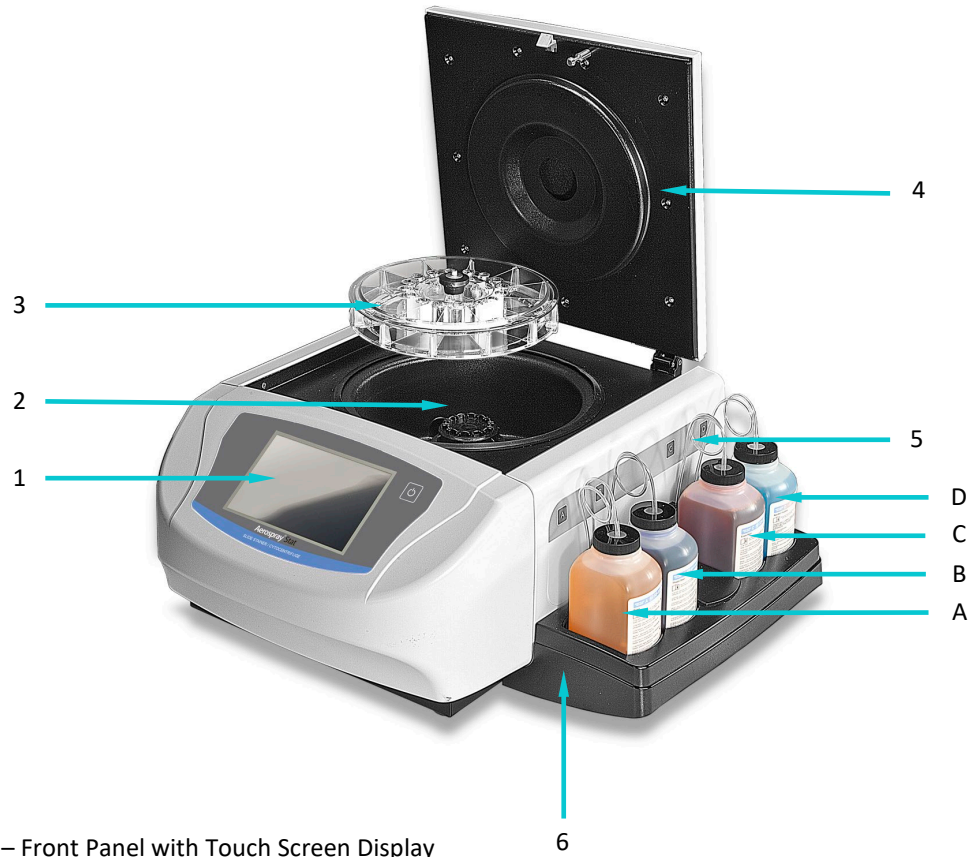

- 1 – Front Panel with Touch Screen Display
- 2 – Bowl
- 3 – Carousel
- 4 – Lid with Safety Lock
- 5 – Right Side Panel with Label Indicating Reagent Positions:
  - A – Rinse
  - B – Thiazin
  - C – Eosin
  - D – Methanol or Aerofix
- 6 – Reagent Tray

**1.2 Instrument Description**

**Figure 2: Front Panel and Touchscreen**

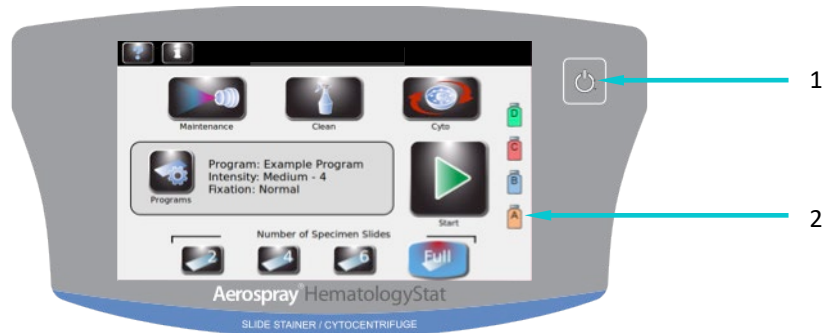

- 1 – Standby/Ready Button
- 2 – Touchscreen

The front panel features an interactive touchscreen display. Refer to Front Panel/Main Screen Function Keys (Section 1.3, Table 8) for more information.

**Figure 3: Rear Panel**

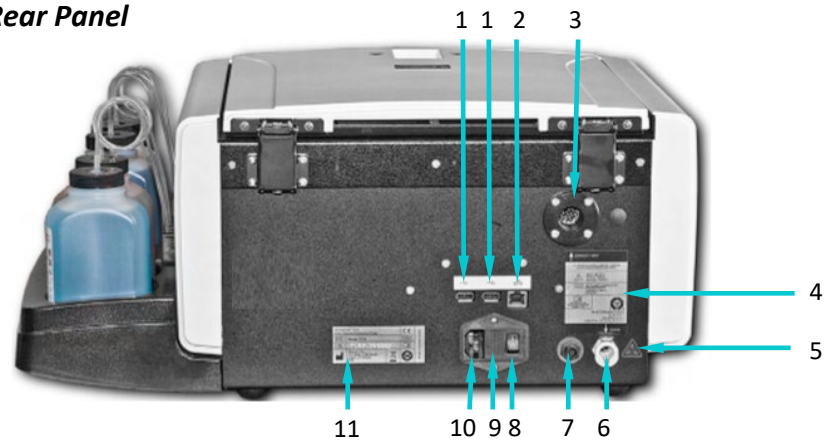

- 1 – USB Ports
- 2 – Network Ethernet Connection
- 3 – Exhaust Vent
- 4 – Rear Panel Label
- 5 – Biohazard Warning Label
- 6 –Waste Tube Connection
- 7 – Level Detection Connection for Waste Container
- 8 – Power Switch
- 9 – Fuse Door
- 10 – Power Cord Connection
- 11 – Model/Serial Number Label

SECTION 1  
INTRODUCTION

**1.2 Instrument Description**

**Figure 4: Stainer Bowl Components**

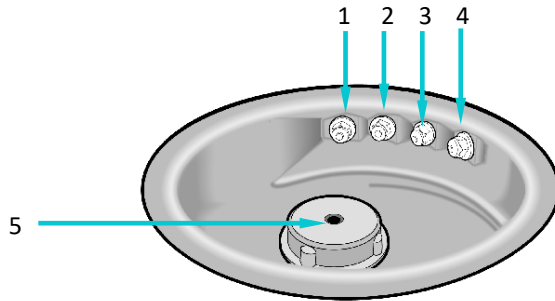

- 1 – Nozzle D (Methanol or Aerofix)
- 2 – Nozzle C (Eosin stain)
- 3 – Nozzle B (Thiazin stain)
- 4 – Nozzle A (Rinse)
- 5 – Drive Hub

**Figure 5: Nozzle Diagram**

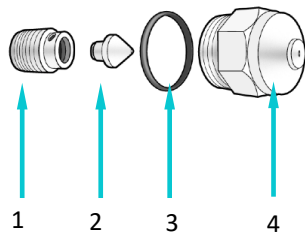

- 1 – Compression Screw
- 2 – Swirl Cone
- 3 – O-Ring
- 4 – Nozzle Housing

SECTION 1  
INTRODUCTION

**1.2 Instrument Description**

**Table 7: Preventive Maintenance Kit**

Component	Name	Description
	Manual Priming Tool	Primes air-locked pumps.
	Silicon Grease	Lubricates the nozzle threads for easy assembly.
	Nozzle Wire	Cleans nozzle housing orifices.
	Nozzle Cleaning Strainer	Strains the nozzle parts to prevent them from going down a drain.
	Nozzle Tool	Unscrews nozzles from the stainer bowl.
	Nozzle Wrench	Disassembles the nozzle.
	Nozzle Brush	Cleans nozzles without removing them from the stainer.

SECTION 1  
INTRODUCTION

**1.2 Instrument Description**

**Table 7: Preventive Maintenance Kit (continued)**

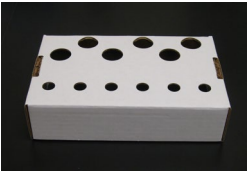
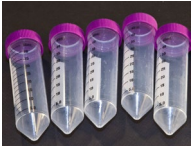
Component	Name	Description
	Volume Test Collection Tubes (small tube)	Collects reagents while performing the Volume Test.
	Nozzle Maintenance Tube Stand	Holds Nozzle Cleaning Tubes (large tube) and Volume Test Tubes (small tube).
	Nozzle Cleaning Tubes (large tube)	For soaking nozzles in the Nozzle Cleaning Solution.

**Barcode Reader**

An optional barcode reader is available for the Hematology Stat Stainer/Cytocentrifuge (Model 7122).









**Figure 6: Barcode Reader**



### 1.3 Touchscreen and User Interface

Users control all instrument functions from the interactive touchscreen display.





**Table 8: Front Panel/Main Screen Function Keys**

Button	Name	Description
	Standby/Ready	With instrument power ON: Blue = Ready Amber = Standby  Pressing Standby runs a System Clean cycle and places instrument into standby mode.  The Standby/Ready button also accesses the touchscreen calibration function. Refer to System Setup Menu (Section 3.1).
	Maintenance	Accesses features for verifying proper nozzle performance and places pumps in a testing sequence. Accesses the line priming, Pattern Test, Volume Test, and B-Line Flush functions.
	Clean	Performs the Clean cycle.
	Cyto	Enters the Cyto centrifuge mode.
	System Information	Shows the system information, including serial number and software version. Allows access to the System Setup features. Refer to System Setup Menu (Section 3.1).
	Help	Opens the software Help file.
	Programs	Allows users to select or edit programs.
	Start/Load Slides	Starts a Stain or Cyto centrifuge cycle. Button is inactive until a program is created. Refer to Creating a Stain Program (Section 3.1).  With Slide Tracking enabled, opens the Scan and Load Slides menu (Section 3.2).
	Number of Specimen Slides	Selects the number of specimen slides in the carousel. Users staining an odd number of specimen slides should press the next higher specimen slide number icon.







SECTION 1  
INTRODUCTION

**1.3 Touchscreen and User Interface**

**Table 8: Front Panel/Main Screen Function Keys (continued)**

Button	Name	Description
	Back	Returns to the previous menu.
	Stop	Aborts any operation.
	OK	Indicates completion of current task.
	System Setup	Allows users to modify the software settings. See System Setup Menu (Section 3.1).













**Table 9: System Setup Keys**

Button	Name	Description
	Stain Programs	Allows users to create, edit, and delete stain programs.
	Cyto Programs	Allows users to create, edit, and delete cyto centrifuge programs.
	Reagents	Allows users to edit reagent information.
	Users	Allows users to create and change user accounts.
	QC/Maintenance Tracking	Enables slide tracking, preventive maintenance tracking, and reagent tracking.
	Level Detect	Allows users to manage the automatic reagent level detection system.
	Language	Allows users to change the display language.
	System Log	Allows users to control logging functions.
	Network Settings	Allows users to change network settings.
	Beeper	Allows users to change audible alerts.



**1.3 Touchscreen and User Interface**







**Table 9: System Setup Keys (continued)**

Button	Name	Description
	Set Date/Time	Allows users to set the date and time.
	Restore Defaults	Restores programming to default settings.
	Login	Enters Login sequence for authorized users.
	Logout	Logs authorized users out. Users must log in again to use the stainer.
	Save	Saves the entered or selected information.
	Add	Enters programming mode for creating staining and cytocentrifuge programs. Also allows the system administrator to authorize new users. Allows manual entry of slide or specimen information.
	Delete/Erase/Remove	Deletes or erases the selected item.
	Edit/Change User	Allows editing of an existing stain or cytocentrifuge program. Allows manual entry of slide or specimen information (stain or cytocentrifuge mode). Also allows system administrator to edit user information.
	Zero	Zeros the Level Detect sensors.
	Calibrate	Calibrates the Level Detect system.
	Unselected	Shows an unselected option.
	Selected	Shows a selected or enabled option.

SECTION 1  
INTRODUCTION

**1.3 Touchscreen and User Interface**

**Table 10: Maintenance Function Keys**

Button	Name	Description
	Individual Prime Buttons (A, B, C, D)	Primes the selected line.
	Pattern Test	Performs Pattern Test to ensure nozzles are clear of debris and spraying properly.
	Volume Test	Performs Volume Test to verify the selected nozzle volume is within the correct range.
	60-Sec Prime	Runs the pumps for 1 minute and primes the lines.
	QC/PM	Shows the Preventive Maintenance and Quality Control logs, when enabled from the System Setup menu (Section 3.1).
	Line Flush	Cleans the B and C reagent lines.
	ABCD Prime button	Primes all (A, B, C, D) reagent lines simultaneously.

## SECTION 2 SETUP AND PREPARATION FOR OPERATION

### **2.1 Instrument Setup**

#### **Unpacking and Installing the Stainer**

Follow this sequence if you are using this instrument for the first time. Details about these operations are given in the next three sections.



**CAUTION:**

Contact ELITechGroup before installing the instrument if you observe any damage to the packaging or equipment.

- 1 Unpack and inspect the instrument.
- 2 Check that the contents of the boxes match the packing lists for the instrument and accessories.
- 3 Open the instrument lid and remove the cardboard tube that protects the hub.

**NOTE:** *Keep the box and packaging material to repack the instrument if you intend to ship it to the manufacturer for service.*

- 4 Place the instrument on a flat surface, free from dust and vibration and away from direct sunlight.

**NOTE:** *Position the instrument with the rear panel at least 30 cm (12 in.) from obstructions or hazardous materials.*



**CAUTION:**

Keep the drain tube straight and as short as possible. The maximum length is 1.8 m (72 in.). The waste container must be positioned lower than the stainer.

## SECTION 2 SETUP AND PREPARATION FOR OPERATION

### 2.1 Instrument Setup

#### Connecting the Drain Tube and Waste Container

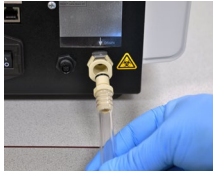

- 1 Insert the waste tube connector into the rear panel receptacle until you hear a click.
- 2 Adjust the tube length to less than 1.8 m (72 in.).

**NOTE:** Ensure the waste tube has no loops or kinks, and is as straight and as short as possible. Cut off excess tubing as needed.



- 3 Connect the drain tube to the waste container.

If using a waste bottle with level detect (REF: AC-182):

- 4 Connect the waste monitoring cable to the rear panel receptacle.
- 5 Connect the waste monitoring cable to the waste container lid.

#### Connecting Power

- 1 Make sure the power switch is **OFF** (O).
- 2 Plug the power cord into the power connector on the rear panel of the instrument.

**NOTE:** Use a surge protector to isolate the instrument from electrical spikes and surges.

- 3 Plug the power cord into a properly rated AC electrical outlet.
- 4 Turn the power switch **ON** (I). After a brief delay the Main menu will appear.



## SECTION 2 SETUP AND PREPARATION FOR OPERATION

### 2.1 Instrument Setup

#### Installing Reagent Bottles



#### WARNING!

Reagents used in the instrument contain moderately hazardous chemicals that require care in handling. Always handle reagents using appropriate safety measures, including gloves and eye protection.



**NOTE:** Reagents should be stored according to the conditions specified on their label. After opening, reagents are stable for 90 days unless otherwise indicated by the symbol shown at left.

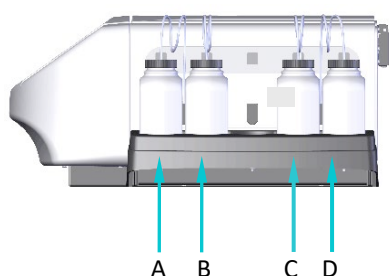

- 1 Place each 500 mL reagent bottle in the correct position.
  - (A) Rinse
  - (B) Thiazin Stain
  - (C) Eosin Stain
  - (D) Methanol

**NOTE:** See Appendix A for complete identification of all reagents used in this stainer.



#### CAUTION:

To avoid severe damage, never use reagents containing organic solvents (such as ketones) in this instrument, unless supplied by ELITechGroup, or specified in official ELITechGroup formulation instructions.

**NOTE:** Immediately remove spills in the reagent tray to preserve the accuracy of the reagent level detecting system.

- 2 For all reagents:
  - Open a new bottle of reagent.
  - Record the reagent letter on each cap.
  - Insert the corresponding dip tube into the reagent bottle and install the ring cap.

## SECTION 2 SETUP AND PREPARATION FOR OPERATION

### **2.1 Instrument Setup**

#### **Installing the Barcode Reader**

A barcode reader can be connected to the stainer for scanning reagent bottles and specimen slides that contain barcodes. This allows easy reagent and specimen information tracking. If a barcode reader is not installed, reagent and specimen information can be entered manually (Section 3.2).



#### **Installing the Barcode Reader**

- 1 Place the barcode reader and stand on a level surface near the stainer.
- 2 Plug the barcode reader into the left USB port on the rear panel of the stainer. See Section 3.2 for instructions on using the barcode reader.

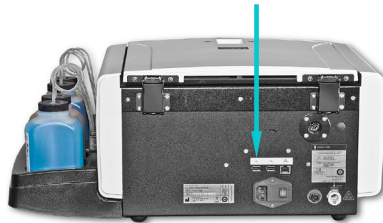

## SECTION 2 SETUP AND PREPARATION FOR OPERATION

### 2.2 Preparing the Stainer for Operation

#### Priming Procedures

**NOTE:** The instrument is shipped with alcohol in the reagent lines. For proper performance, this alcohol must be replaced with the correct reagent for each reagent line prior to use.

Thoroughly purge and prime each reagent delivery line using the following instructions.

- 1 Remove each spray nozzle with the provided nozzle tool by turning counterclockwise.

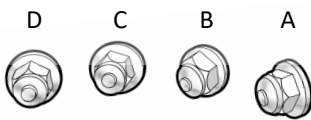

- 2 Note the location of each nozzle so you can return it to the original position during reassembly.

- 3 Place a carousel on the stainer hub to prevent stain from entering the motor shaft.



**CAUTION:**

Fluid from priming can flood and damage the motor if the drain tube is not properly installed.

- 4 Press **Maintenance** from the Main menu.



- 5 Press the **A** prime button. Stain should appear within 10 seconds. When properly primed, a steady stream of reagent (no sputtering or breaks) flows from the nozzle receptacle.



- If stain appears, proceed to the next step.

- If stain does not appear within 10 seconds, perform the manual priming procedure (Section 6.3).



**CAUTION:**

Never operate a dry pump for more than 10 seconds. Operating a dry pump may cause damage to the instrument.

## SECTION 2 SETUP AND PREPARATION FOR OPERATION

### 2.2 Preparing the Stainer for Operation

#### Priming Procedures (continued)

- 6 Repeat the previous steps for each reagent line (B, C, and D).

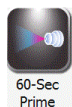

- 7 Press **60-Sec Prime** to prime each reagent line with 200 mL of reagent to remove all of the alcohol from the reagent lines and pumps.

**Note:** Repeat 60-sec prime 2-3 times to ensure each line is primed sufficiently.



- 8 To prime all lines at the same time, press **ABCD**. The pumps will run for 1 minute and prime all the lines. Follow instructions on the screen.



**NOTE:** To prime individual lines, press the appropriate individual prime button (A, B, C, D).

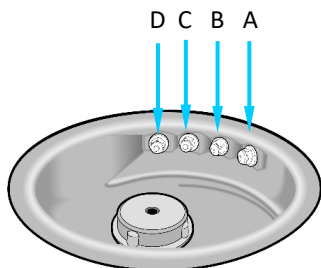

- 9 Return the nozzles to their original positions and tighten clockwise with the nozzle tool.

- 10 With the nozzles installed, repeat Steps 5 and 6. A fine cone of spray should come from each nozzle.

- 11 After verifying nozzle performance, a clean cycle must be performed before a stain cycle can be run.



## SECTION 2 SETUP AND PREPARATION FOR OPERATION

### 2.2 Preparing the Stainer for Operation

#### The Clean Cycle

The Clean cycle is a two-step process that cleans the reagent nozzles and the carousel. The first step purges each reagent line and cleans the empty carousel with methanol or Aerofix while cycle progress is displayed on the screen. The second step, which can be delayed indefinitely, reprimes the reagent lines with staining reagents.

**NOTE:** Pressing Standby/Ready performs a System Clean cycle before the instrument goes on standby.

- 1 Place an empty carousel in the instrument and close the lid.



**CAUTION:**

Never place any carousel loaded with specimens in the instrument for a clean cycle (including placing the instrument in standby mode). Specimens will be damaged if they contact reagents sprayed from the nozzles when you press Clean or Standby.



- 2 Press **Clean**.



**NOTE:** Pressing Stop during the Clean cycle causes the Clean Cycle Cancelled message to be displayed. Press Clean to complete the interrupted cycle.

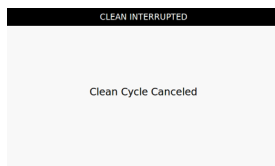

- 3 Press **Reprime** to reprime the lines.

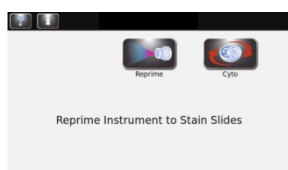

- 4 Open the lid and remove the carousel when the Clean cycle is complete.
- 5 Spray the interior of the bowl with 70 to 100% methanol or ethanol. Wipe the stainer bowl dry with paper towels.

**NOTE:** Perform the instrument storing procedure (Section 5.2), if the instrument will remain idle for more than 1 week.

#### Performing Tests

We recommend performing the Pattern Test and Volume Test before using the stainer (see Section 6).

## SECTION 2 SETUP AND PREPARATION FOR OPERATION

### 2.2 Preparing the Stainer for Operation

#### Reagent Level Monitoring



Reagent Level Detect monitors reagent levels and alerts you when the reagent is running low, or when the waste container is full (when using the waste container with level detect (AC-182)). You can turn reagent and waste container monitoring ON or OFF from the Level Detect menu. The system default is ON for reagent monitoring and OFF for waste container monitoring.

**NOTE:** The instrument must be installed on a flat, level surface for accurate reagent monitoring.



#### CAUTION:

This system is designed to warn you when the reagent level is getting low. The instrument will continue running through these warnings. Always monitor and replenish (if needed) the reagent before running a stain cycle.

#### Enabling/Disabling Reagent Level Detect



- 1 Press **Information** from the Main menu.



- 2 Press **System Setup**.



- 3 Press **Level Detect**. The display shows:

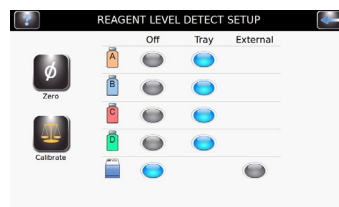

- 4 Press **Tray** to enable, or **OFF** to disable a reagent line. Functions are grey when unselected, blue when selected. Press **External** to enable level detect for the waste bottle.



- 5 When finished, press **Back** to exit to System Setup menu.

## SECTION 2 SETUP AND PREPARATION FOR OPERATION

### ***2.2 Preparing the Stainer for Operation***

#### **Zeroing the Reagent Level Sensors**

The Level Detect function must be zeroed at initial setup, when the stainer is moved, or if the level detect is not reporting correctly. If zeroing does not correct the problem, recalibrate the Level Detect function (Section 7.3).



- 1 Press **Information**.



- 2 Press **System Setup**.



- 3 Press **Level Detect** to enter the Reagent Level Detect Setup menu.

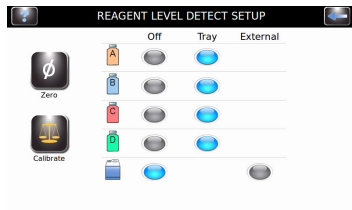

**NOTE:** The stainer should be turned ON for at least 30 minutes before zeroing to stabilize level sensors. The instrument can be used during this time.



- 4 Press **Zero**. The display shows:



## SECTION 2 SETUP AND PREPARATION FOR OPERATION

### 2.2 *Preparing the Stainer for Operation*

#### Zeroing the Reagent Level Sensors (continued)



- 5 Remove all reagent bottles and press **Start**.

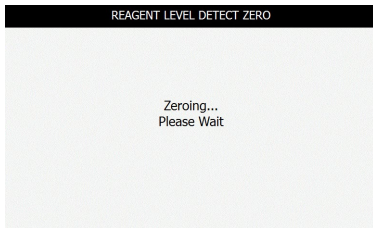

**NOTE:** *Vibrations or bumps to the instrument or lab bench can cause inaccuracies in zeroing or calibration.*



- 6 After zeroing, press **OK**. Press the **Back** button to exit to the System Setup menu.



- 7 Return the reagent bottles to their correct positions in the tray.

**NOTE:** *For accurate reagent level detection and calibration, dip tubes must follow their pre-formed coiled shapes.*

## SECTION 3 CONTROLLING AND CUSTOMIZING STAINER FUNCTIONS

### 3.1 System Setup Menu

Many software settings can be controlled from the System Setup menu, including:

- Creating, editing, and deleting stain programs
- Creating, editing, and deleting cytocentrifuge programs
- Tracking reagent information
- Managing user accounts
- Enabling tracking features for slides, maintenance, and reagents
- Managing reagent level sensing
- Changing the display language
- Viewing and exporting the system log
- Changing beeper settings
- Setting the date and time
- Restoring default settings

#### Accessing the System Setup Menu



- 1 Press **System Information** from the Main menu.



- 2 Press **System Setup**.



#### Stain Programs

Stain Programs allows the user to create, edit, or erase staining programs according to the user's specific staining requirements. Up to 12 staining programs can be programmed and stored in memory.

Programmable staining parameters include stain intensity and fixation options.

- **Stain Intensity**  
Selections range from 1 to 10. 1 is the lightest and 10 the darkest setting. Settings 8, 9, and 10 are particularly appropriate for bone marrow specimens.
- **Fixation**  
Fixation options are Off, Normal, and High.

## SECTION 3 CONTROLLING AND CUSTOMIZING STAINER FUNCTIONS

### 3.1 System Setup Menu

#### Creating a Stain Program

- 1 From System Setup, press **Stain Programs**.

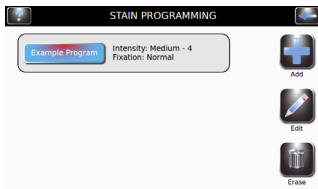

- 2 Press **Add**.

- 3 Select **Enter Program Name**, and enter the desired name on the keypad.

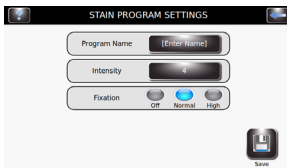

- 4 Press **Enter** on the keypad. The display returns to the Stain Programming Menu.

- 5 Select **Intensity** From the Stain Programming Menu. Select the desired stain intensity (1-10).

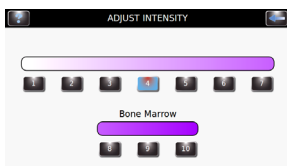

- 6 Select the desired Fixation (Off, Normal, High).

- 7 Press **Save**.



#### Editing, Renaming, or Adjusting Stain Programs

- 1 From Stain Programs menu select the program to be modified.

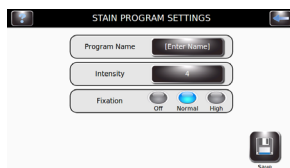

- 2 Press **Edit**.

## SECTION 3 CONTROLLING AND CUSTOMIZING STAINER FUNCTIONS

### 3.1 System Setup Menu

#### Editing, Renaming, or Adjusting Stain Programs (continued)

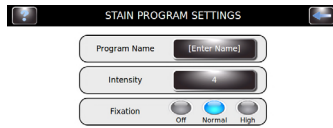

- 3 Adjust the settings as needed.



- 4 Press **Save**.



#### Administrator and User Accounts

You can create one Administrator account and multiple (up to 50) user accounts. The Administrator controls access to the system by adding and editing user accounts. Users cannot edit System Settings unless permitted by the Administrator.

##### Creating an Administrator Account

- 1 From System Setup, press **Users**.



- 2 Select **Lock System Setup Access**.



- 3 Enter a password for the Administrator account (at least 4 characters) and press **Enter**.

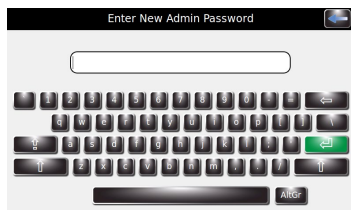

- 4 Re-enter the password and press **Enter** to confirm.



## SECTION 3 CONTROLLING AND CUSTOMIZING STAINER FUNCTIONS

### 3.1 System Setup Menu

#### Creating User Accounts

**Note:** This function is available only if an administrator account has been created.



- 1 Select **System Setup**.
- 2 Enter the Administrator password.



- 3 Press **Enter**.



- 4 Select **Users** to reveal the Manage Users menu.

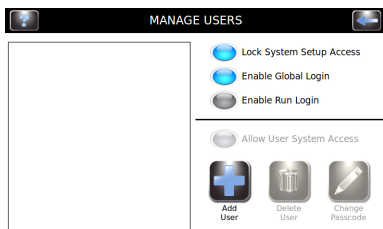

- 5 Select **Enable Global Login**.



- 6 Select **Add User**.

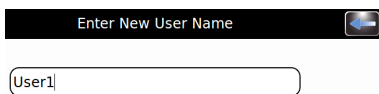

- 7 Enter a new user name.



- 8 Press **Enter**.



## SECTION 3 CONTROLLING AND CUSTOMIZING STAINER FUNCTIONS

### 3.1 System Setup Menu

#### Creating User Accounts (continued)



9 Enter a numeric passcode (at least 4 numbers) for the user account.

10 Press **Enter**.



11 Re-enter the passcode to confirm.



12 Press **Enter**.



#### Managing User Access

From the Manage Users screen, the Administrator has several options to manage user access to the instrument.

- Enable Global Login allows users to log in to the instrument. Users will log out manually or automatically (with user-selectable time options). See User Login/Logout below.
- Enable Run Login requires the current user to enter a password to run a Stain or Cytocentrifuge cycle. Global Login must be enabled to use this option.
- User System Access enables complete control of the instrument, including changing the System Setup options. This option can be controlled on an individual user basis, if Global Login is enabled.

#### User Login/Logout

With System Access locked and Global Login enabled, users must log in to use the stainer:

- 1 Select **User ID** and **Select Logout** time after idle from the drop-down menu.

**NOTE:** Users can select how long the stainer can be idle before automatically logging the user out.

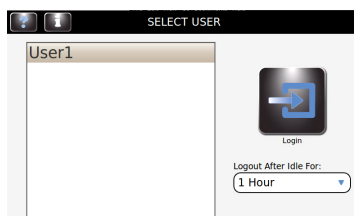

## SECTION 3 CONTROLLING AND CUSTOMIZING STAINER FUNCTIONS

### 3.1 System Setup Menu

#### User Login/Logout (continued)



2 Press **Login**.

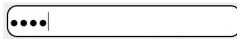

3 Enter the correct passcode for the selected user and press **Enter**.



4 Once Login is complete, the display advances to the Main screen and the instrument is ready for programming and staining. A Logout button and the user name appear at the top right of the Main screen. Users can log out manually by pressing the logout button.



## SECTION 3 CONTROLLING AND CUSTOMIZING STAINER FUNCTIONS

### **3.1 System Setup Menu**

#### **Using Reagent Information Tracking**

You can enter reagent information to help track reagent usage and expiration. Reagent information includes reference number, expiration date, lot number, date and time the reagent was last installed.



- 1 From System Setup, press **QC/Maintenance Tracking**.
- 2 Select **Enable Reagent Tracking** by choosing reagent A, B, C, or D. This enables reagent lot number and expiration date tracking.
- 3 Press **Back** to return to System Setup.
- 4 Press **Reagents**.
- 5 Press **Change** next to the appropriate reagent.
- 6 Scan the reagent bottle barcodes (Section 3.2) or manually enter the reagent information in the correct fields.
- 7 Press **Save** for each reagent.
- 8 Repeat steps 5 to 7 for each reagent.

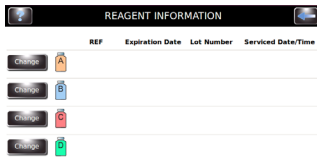
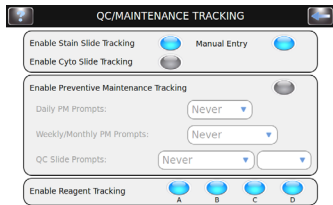

#### **Modifying Level Detect Functions**

The Level Detect function alerts you when the reagent is running low, or when the waste container is almost full. You can turn reagent and waste container monitoring ON and OFF from the System Setup screen. The system defaults to ON for reagent monitoring and to OFF for waste container monitoring. See Section 2.2 for complete instructions.



- 1 From System Setup, press **Level Detect**.
- 2 Select the reagent monitoring options to be modified.
  - To disable monitoring, press **OFF** next to the appropriate reagents.
  - To enable monitoring, press **Tray** next to the appropriate reagents.
  - To monitor the waste container, press **External**.

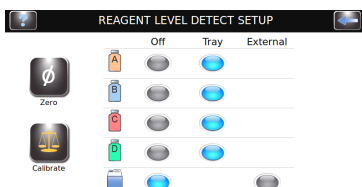

## SECTION 3 CONTROLLING AND CUSTOMIZING STAINER FUNCTIONS

### 3.1 System Setup Menu

#### Changing User Language



- 1 From System Setup, press **Language**.
- 2 Select the software language from the list on the left.



- 3 Press **OK**.

#### Setting the Date and Time



- 1 From System Setup, press **Set Date/Time**.

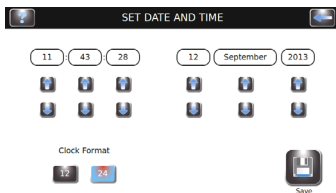

- 2 Select **12** for a 12-hour clock or **24** for a 24-hour clock.
- 3 Use the up and down arrows to modify the time and date.



- 4 Press **Save**.

#### System Log

The instrument records all login, logout, stain or cytocentrifuge cycles, setting changes, maintenance functions and specimen identification (if enabled).

##### Accessing Logs



- 1 From System Setup, press **System Log**.
- 2 Use navigation arrows to scroll through the log.

Date/Time	User	Type	Status	Information
2013-09-12 11:42:23		Reagent	Serviced	A: Srv: 12-Sep-2013 11:41
2013-09-12 11:41:33		Slide Tracking	Setting	Stain Slide Tracking Enabled
2013-09-12 11:41:22		System		System Settings Accessed
2013-09-12 11:41:09		System	Power On	
2013-09-12 11:41:05	Admin	Defaults	Loaded	System
2013-09-12 11:41:00	Admin	Login		System Settings Accessed
2013-09-12 11:40:02	User1	Login		1 Hour
2013-09-12 11:39:20	Admin	Logout		Manual

Navigation: Week 37, 2013 | Export

## SECTION 3 CONTROLLING AND CUSTOMIZING STAINER FUNCTIONS

### 3.1 System Setup Menu

#### System Log (continued)

##### Exporting Logs

- 1 From System Setup, press **System Log**.
- 2 Plug a Flash Drive into the right USB port.
- 3 Press **Export**.

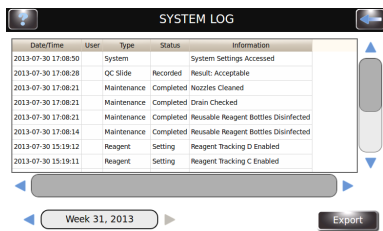

**NOTE:** The log files are exported to the Flash Drive as a CSV file that can be used in spreadsheet software programs.

#### Controlling Beeper Alerts

- 1 From System Setup, press **Beeper**.

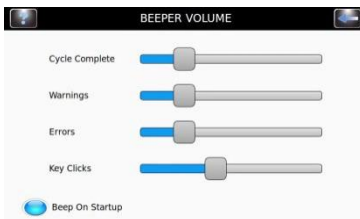

- 2 Use the sliders to modify the beeper volume for Cycle Complete, Warnings, Errors, or Key Clicks.
- 3 Press **Beep On Startup** to turn the audible startup alert ON or OFF.

## SECTION 3 CONTROLLING AND CUSTOMIZING STAINER FUNCTIONS

### 3.1 System Setup Menu

#### QC/Maintenance Tracking

Under system default settings, the following QC/Maintenance Tracking options are disabled:

- Stain Slide Tracking
- Cyto Slide Tracking
- Manual Entry
- Preventive Maintenance Tracking
- Reagent Tracking

#### Enable Stain Slide Tracking

To activate Stain Slide Tracking:

1 From System Setup, Press **QC/Maintenance Tracking**.



2 Press **Enable Stain Slide Tracking**.

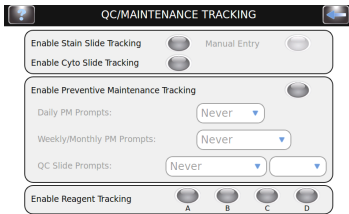

3 Press **Back** twice to return to the main screen. Verify that the Start Button on the main screen reads “Load Slides.”



**NOTE:** Selecting *Enable Stain Slide Tracking* changes the Start button on the Main menu to “Load Slides.”

4 Press **Load Slides**. The Scan and Load Slides menu appears.

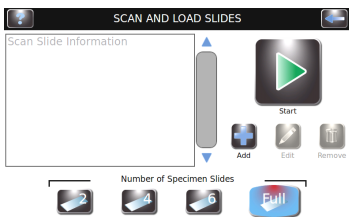

5 Enter slide information.

- If using the barcode reader, scan the specimen slides that contain barcodes. See Scanning Slides with the Barcode Reader (Section 3.2).
- If entering specimen information manually, see Manually Entering Specimen Information (Section 3.2).



6 See Section 4 for remaining steps for running a stain cycle.

## SECTION 3 CONTROLLING AND CUSTOMIZING STAINER FUNCTIONS

### 3.1 System Setup Menu

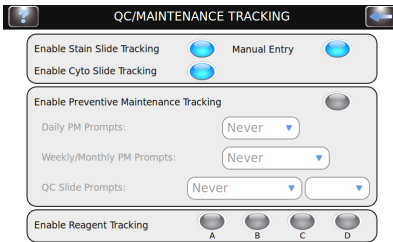

#### Enable Cyto Slide Tracking

Allows slide tracking in cytocentrifuge mode. See the Cytopro Rotor Applications Manual (Aerospray Models 7xx2) (REF: RP-517) for complete information.

#### Enable Manual Entry

If selected, allows manual entry of slide information using the keypad (limited to 24 characters).

#### Enable Preventive Maintenance Tracking

To activate the tracking prompts for Preventive Maintenance Tracking, use the following steps:

- 1 From System Setup, select **QC/Maintenance Tracking**.
- 2 Select **Enable Preventive Maintenance Tracking**.

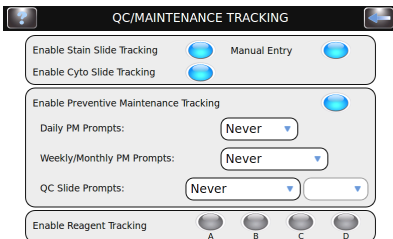

- 3 Enter the information for the Daily, Weekly, and QC Slide prompts in corresponding fields. Instructions for using the Preventive Maintenance Log are detailed in Section 5.1.

#### Enable Reagent Tracking

To activate Reagent Tracking:

- 1 From the **QC/Maintenance Tracking** menu, select the reagent (A, B, C, D) to be tracked.

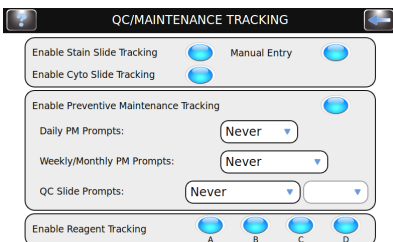

## SECTION 3 CONTROLLING AND CUSTOMIZING STAINER FUNCTIONS

### 3.1 System Setup Menu

#### Restoring Software Defaults



- 1 From System Setup, select **Restore Defaults**.



#### **CAUTION:**

Restoring the system defaults will remove all personal settings.

- Restoring System Settings will delete all user names and passwords.
- Restoring Stain Settings will delete all stain programs and restore the default programs.
- Restoring Cytocentrifuge Settings will delete all cytocentrifuge programs and restore the default programs.

- 2 Select the settings you would like to restore to factory defaults: System Settings, Stain Settings, or Cytocentrifuge Settings.



- 3 Press **Restore**.



- 4 The display returns to the Main menu.



## SECTION 3 CONTROLLING AND CUSTOMIZING STAINER FUNCTIONS

### 3.2 Recording Specimen and Reagent Information

#### Scanning Slides with the Barcode Reader



1 From System Setup select **QC/Maintenance Tracking**.

2 Select **Enable Stain Slide Tracking**.

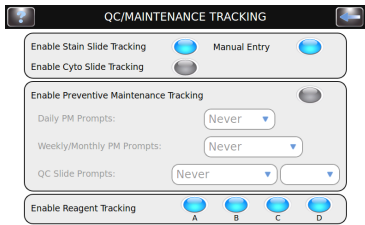

**NOTE:** Selecting *Enable Stain Slide Tracking* changes the *Start* button on the *Main* menu to “*Load Slides*.”



3 Press **Back** twice to return to the Main menu.



4 Press **Load Slides** on the Main menu. The Scan and Load Slides menu will appear.

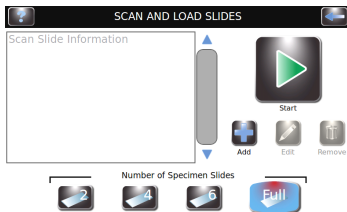

5 Scan the barcode of each slide in the batch and load into the carousel according to instructions in Section 4.1.



6 Verify that each barcode appears on the Scan and Load Slides menu.

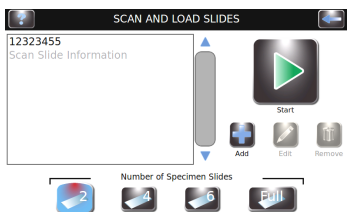

7 When you have completed preparations to stain, (Section 4.1) press **Start**.



## SECTION 3 CONTROLLING AND CUSTOMIZING STAINER FUNCTIONS

### 3.2 Recording Specimen and Reagent Information

#### Scanning Reagent Bottles with the Barcode Reader



1 From System Setup select **QC/Maintenance Tracking**.

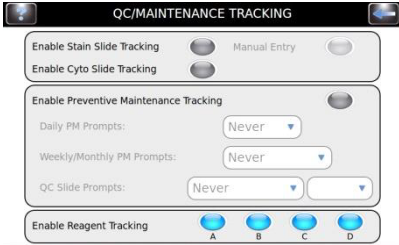

2 Select **Enable Reagent Tracking** for each desired reagent (A, B, C, D).



3 Press **Back** to return to the System Setup menu.



4 Press **Reagents** to reveal the Reagent Information screen.

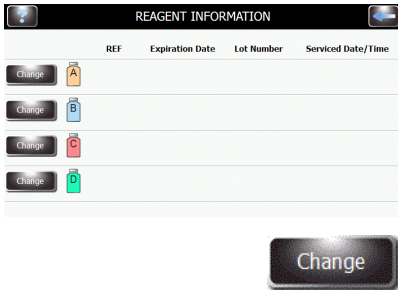

5 Select the desired Reagent (A, B, C, D) and press **Change**.



6 Scan the barcode of each enabled reagent bottle.

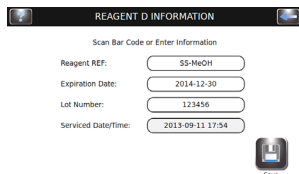

7 Verify that the barcode appears on the Scan and Load Slides menu.

SECTION 3  
CONTROLLING AND CUSTOMIZING STAINER FUNCTIONS

**3.2 Recording Specimen and Reagent Information**

**Scanning Reagent Bottles with the Barcode Reader (continued)**



8 Press **Save**.

9 Repeat steps 3-8 for each reagent bottle that is enabled in QC Maintenance Tracking.



**NOTE:** You can access Reagent Information by pressing the bottle icons on the right side of the Main menu. This takes you directly to Reagent Information menu, where you can scan or manually enter reagent information by pressing Change.

**Manually Entering Specimen Information**

With Stain Slide Tracking and Manual Entry enabled in the QC Maintenance menu:



1 Press **Load Slides** on the Main menu.



2 Press **Add** to reveal the keypad.



3 Enter slide information (maximum of 24 characters) and press **Enter**.



4 To change or delete the entry, select the entry on the display and press **Edit** or **Remove**.



5 Load slides and run stain cycle as shown in Section 4.1.

**NOTE:** Reagent REF number must be a valid ELITechGroup REF number for the selected reagent. Incorrect entries will generate an error message.

# SECTION 3 CONTROLLING AND CUSTOMIZING STAINER FUNCTIONS

## 3.2 Recording Specimen and Reagent Information

### Manually Entering Reagent Information



- 1 Press **Reagents** from the System Setup menu, or press the reagent status icon on the Main menu to reveal the Reagent Information menu.

- 2 Select the desired reagent and press **Change**.

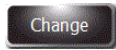
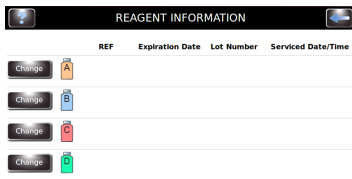

- 3 Select the desired field (Reagent REF, Expiration Date, Lot Number, or Service Date/Time).

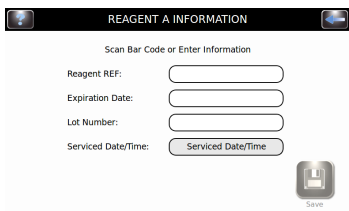

- 4 Enter the information on the keypad and Press **Enter**.

- 5 Press **Save**.

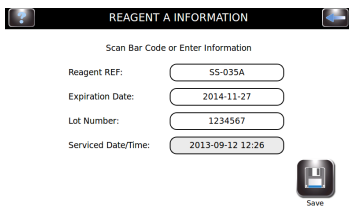

## SECTION 3 CONTROLLING AND CUSTOMIZING STAINER FUNCTIONS

### ***3.3 The Help Menu***

The Help menu is a comprehensive onscreen help function that provides detailed information on the following subjects:

#### **Help Screens**

##### **Basic Operation**

- Loading the Carousel
- Programming Number of Slides
- Select Intensity Setting
- Correct Reagents and Locations
- Selecting a Staining Program

##### **Touchscreen**

##### **Calibrating the Touchscreen**

##### **Cleaning**

Clean Cycle

#### **Using Help**



1 Press **Help** to access the help function.

2 Select the desired topic.



3 Use the direction arrows to navigate.



4 Press **Exit** to return to the Main menu.

## SECTION 4 OPERATING THE STAINER

### 4.1 Operating Instructions



#### WARNING!

Treat slides in accordance with good laboratory practices and local regulations.

#### Suggested Staining Protocol

- Hub Pattern Test (once per day).
- Select or verify desired stain program.
- If slide tracking is enabled, scan or enter slide information.
- Load slides into the carousel. Use blocking slides if needed.
- Place loaded carousel into the stainer and close the lid.
- Check reagent and waste levels.
- If slide tracking is not enabled, enter the number of slides on the Main menu.
- Perform a stain cycle.
- Unload the carousel.

#### Performing a Hub Pattern Test

Use the Hub Pattern Test to ensure the nozzles are clear of debris and spraying properly.

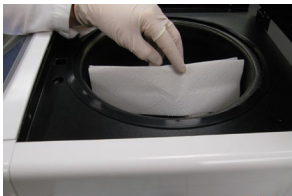

- 1 From the Maintenance menu, Press **Pattern Test**.
- 2 Hold a sheet of white paper towel near the drive hub, squarely facing the target nozzle.



- 3 Press the corresponding prime button.

Check the pattern. If incorrect, clean the nozzle orifice with the nozzle brush provided in the Nozzle Maintenance Kit. If this fails to correct the problem refer to Nozzle Maintenance and Performance (Section 6).

#### Figure 7: Correct Hub Pattern Test Result



#### Figure 8: Incorrect Hub Pattern Test Result

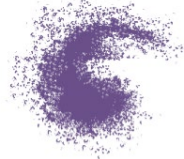

## SECTION 4 OPERATING THE STAINER

### 4.1 Operating Instructions

#### Loading the Carousel



**CAUTION:**

Never load chipped or cracked slides into the instrument. Slides in poor condition may break during the staining cycle. If a slide breaks in the bowl, see Cleaning Broken Slides (Section 5.4).



**CAUTION:**

Keep small ferrous metal objects away from the lab bench. These objects can be attracted to the magnets on the bottom of the carousel and cause damage if spun free during instrument operation.



**CAUTION:**

Load slides in balanced pairs. If staining an odd number of slides, use a blank slide to balance the carousel.

**NOTE:** Load the carousel with similar specimens for a similar level of staining. There is no guarantee of staining performance when dissimilar specimens are used.

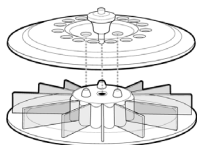

- 1 Remove the carousel from the bowl and place it on a solid, level surface.

- 2 Remove the carousel lid by pressing the button and lifting the lid.



- 3 If Slide Tracking is enabled, press **Load Slides**.

- If using the barcode reader, scan each specimen slide barcode before loading it into the carousel. Slide Tracking must be enabled from the System Setup menu. See Enable Stain Slide Tracking (Section 3.1).
- If entering slide information manually, follow the instructions in Section 3.2.



- 4 Insert the slides into the carousel with the first slide in position 1.

- Load slides in balanced pairs (directly opposite one another) to balance the carousel. If staining an odd number of slides, use a blank slide to balance the carousel.
- If there are empty slots in the carousel, use blocking slides to prevent overspray (see below).

## SECTION 4 OPERATING THE STAINER

### 4.1 Operating Instructions

#### Loading the Carousel (continued)

- Load slides with the labels toward the outside edge of the carousel.
- Always load slides with the specimen facing clockwise.
- Always place the first slide in position 1, the second in position 2, and so on.

**NOTE:** A warning will sound during the staining cycle if the carousel is unbalanced.

**Figure 9: Loading the Carousel**

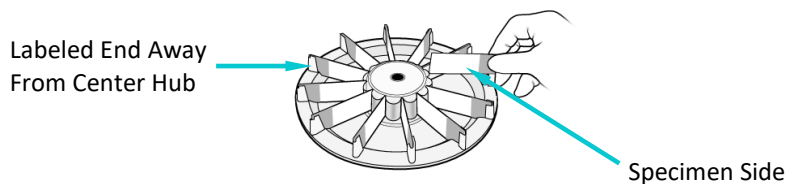

**Figure 10: Specimen Placement on Slide**

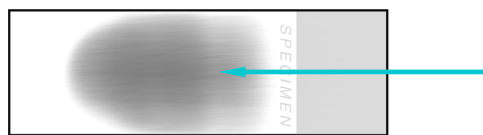

- 5 Replace the carousel lid by pressing the button and lowering the lid over the indexing posts.

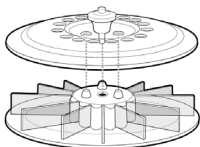

- 6 Release the button and press the lid handle until it is firmly closed and locked.



SECTION 4  
OPERATING THE STAINER

**4.1 Operating Instructions**

**Using Blocking Slides**

If the carousel is not full, blank slides should be used as blocking slides. Blocking slides prevent overspray of reagents onto the specimen slides. Overspray can cause slides to become over-stained.

- Place a blocking slide in front of position 1 and 2.

**Figure 11: Using Blocking Slides**

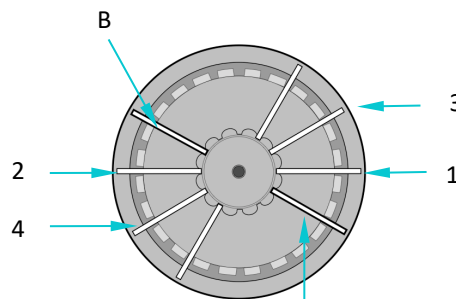

- B – Blocking Slide
- 1 – Slide Position 1
- 2 – Slide Position 2
- 3 – Slide Position 3
- 4 – Slide Position 4

**Performing a Stain Cycle**



- 1 Insert a carousel loaded with specimen slides and close the instrument lid.
- 2 If you have not enabled Slide Tracking, select the number of slides to be stained. Slide selection defaults to full carousel at the end of the run, after pressing Stop, or selecting a number greater than the full carousel default.

**NOTE:** To stain an odd number of specimen slides, select the next higher number listed on the display. For example: to stain 3 slides, select 4, etc.



**NOTE:** If entering slide information by barcode reader or keypad, the number of slides is programmed automatically. Adjust the total number of slides if adding other specimen slides that have not been entered by barcode reader or keypad.

**NOTE:** Do not include blocking slides in the total number of slides.

## SECTION 4 OPERATING THE STAINER

### 4.1 Operating Instructions

#### Performing a Stain Cycle (continued)

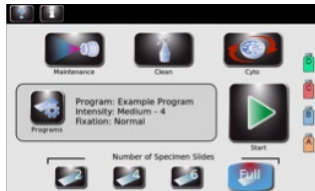

- 3 If you have created a stain program, and it appears on the display, proceed to Step 4. If the desired program does not appear on the display, press **Programs**. Then select the desired program and proceed to Step 4.

**NOTE:** No special collection, pre-treatment, or storage conditions are required for specimen types. Specimens that are normally manually hematology stained can be stained with the Hematology Stat Stainer. Adjust stain settings to maximize staining quality for each specimen type (see Section 3.1).

- 4 Press **Start**. The display shows the progress of the program, and a signal tone (if enabled) indicates the end of the cycle.

**NOTE:** Use the emergency Stop button when required, for example, if there is abnormal vibration or noise. This will abort the staining cycle.



RUNNING STAIN CYCLE

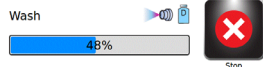

#### Unloading the Carousel

- 1 Remove the carousel from the bowl and place it on a solid, level surface.

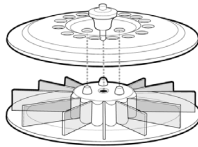

- 2 Remove the carousel lid by pressing the button and lifting the lid.
- 3 Carefully remove each slide, coverslip if desired and observe the specimen using a microscope.

## SECTION 4 OPERATING THE STAINER

### **4.1 Operating Instructions**

#### **Monitoring Reagent and Waste Levels**

If enabled, the stainer displays the approximate reagent and waste container levels and other information.



**CAUTION:**

You must monitor the reagent and waste container levels on the display (if enabled) and by direct inspection of the bottles. The monitor will show the approximate level of each reagent. This can be compared to the actual level in the bottles.

- Never allow a reagent to run dry. When the reagent level is near empty, replace the reagent bottle with a new one (see below).
- Never allow the waste container level to go above the maximum safety level.

**Table 11: Reagent Level Detect Display Symbols**

	Reagent unselected in Level Detect
	Reagent Bottle Full
	Reagent Bottle 2/3 Full
	Reagent Bottle 1/3 Full
	Reagent Bottle Empty
	Measurement Error (internal level detect problem)
	Reagent has exceeded expiration date (enabled from QC Maintenance menu)
	Waste bottle empty
	Waste bottle error (such as external bottle unplugged)
	Waste bottle full

## SECTION 4 OPERATING THE STAINER

### 4.1 Operating Instructions

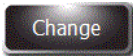

**NOTE:** Access the Reagent Information menu by pressing the bottle icons on the right side of the Main menu. Press **Change** to scan or manually enter reagent information.

**NOTE:** Do not put residual reagent from a used bottle into a new bottle. This can lead to an accumulation of residue on the slides and may be a source of contamination.



#### **WARNING!**

Reagents used in this instrument contain moderately hazardous chemicals that require care in handling. Always use appropriate safety measures, including gloves and eye protection, when handling reagents.

#### Replacing a Reagent Bottle

- 1 Remove the empty reagent bottle from the tray but do not disconnect the dip tube.
- 2 Open the new bottle and record the letter on the cap for future use, such as long-term storage.
- 3 Open the Reagent Information menu by pressing the reagent bottle icon on the right side of the Main menu.
- 4 Select the desired reagent and press **Change**.

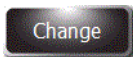

- 5 If you are using reagent tracking, scan the barcode or manually enter the reagent REF, expiration date and lot number in the Reagent Information menu (Section 3.2).
- 6 Unscrew the cap and remove the dip tube from the empty bottle.
- 7 Insert the dip tube into the new reagent bottle and screw on the cap.
- 8 Place the new bottle in the tray.

#### Emptying the Waste Container

The Level Detect function automatically monitors the waste level and indicates when the waste container should be emptied. It is still necessary to check waste levels visually to ensure the waste container does not overflow.



#### **CAUTION:**

Dispose of collected waste according to local statutes and safety requirements.



- 1 Unscrew the cap from the full waste container.
- 2 Discard the waste according to local regulations.
- 3 Reinstall the cap on the empty waste container.

## SECTION 5 PREVENTIVE MAINTENANCE AND SAFETY

### **5.1 Preventive Maintenance**

The system provides a Preventive Maintenance Log for tracking the most recent maintenance activities. See Enable Preventive Maintenance Tracking (Section 3.1) and Using the Preventive Maintenance Log in this section. A manual Preventive Maintenance Log (SS-265) is also available.

#### **Daily Maintenance/Quality Control (QC)**

- 1 Check reagent levels and expiration dates.
- 2 Empty the waste container if necessary.
- 3 At the beginning of the day:
  - Perform a Hub Pattern test.
  - Run a QC slide if required by your laboratory.

**NOTE:** *If staining will not be performed immediately, run a clean cycle after Hub Pattern test.*
- 4 If necessary, use the nozzle brush from the Maintenance Kit to clean the nozzle orifices. Press the individual bristles into the nozzle openings.
- 5 At the end of the day, end of each shift, or if the instrument will be idle for more than four hours:
  - Place an empty carousel in the bowl and close the lid. Press **Standby/Ready** on the front panel and wait until the end of the automatic cleaning process.
  - Spray and wipe the bowl, interior lid, and nozzles with 70 to 100% alcohol.
  - Wipe down the exterior of the instrument with 70 to 100% alcohol.
- 6 Ensure the maintenance procedures listed on the Maintenance Log have been performed, and entered into the chart or log.

#### **Weekly Maintenance**

- 1 Wipe the carousel tray and lid using 70 to 100% alcohol.
  - 2 Perform a Volume Test (Section 6.4).
  - 3 Perform a Hub Pattern Test (Section 4.1).
- NOTE:** *If staining will not be performed immediately, run a clean cycle after Volume and Hub Pattern tests.*
- 4 Manually clean the nozzles if necessary.
  - 5 Wipe the carousel tray and lid using 70 to 100% alcohol.
  - 6 Slowly pour 200-300 mL of water into instrument drain to prevent buildup of paper fibers, precipitates, etc. Verify drain is flowing properly and not allowing fluid to back up in bowl or flow out of air vent on case back.
  - 7 Ensure the maintenance procedures listed on the Maintenance Log have been performed, and entered into the chart or log.

# SECTION 5 PREVENTIVE MAINTENANCE AND SAFETY

## 5.1 Preventive Maintenance

### Monthly Maintenance

- 1 Disassemble and manually clean all nozzles. Refer to Nozzle Disassembly and Cleaning (Section 6.1).
- 2 Perform a Volume Test (Section 6.4) and a Hub Pattern Test (Section 4.1).

**NOTE:** *If staining will not be performed immediately, run a clean cycle after Volume and Hub Pattern tests.*

- 3 Disinfect any reagent bottle that is being reused (Section 5.5).
- 4 Ensure the maintenance procedures in the Preventive Maintenance (PM) Log have been performed and entered into the PM chart or log.

### Using the Preventive Maintenance Log

With Preventive Maintenance Tracking enabled, the PM Log provides a convenient and structured means of recording important maintenance and QC functions. The system allows you to set up timely prompts that require response by the user. See Enable Preventive Maintenance Tracking (Section 3.1).



- 1 From the Maintenance menu, press **QC/PM** to open the PM Log.

Hub Pattern		Nozzle Volume	
Date Completed	Result	Date Completed	Result (ml)
A		A	
B		B	
C		C	
D		D	

Maintenance		QC Slides	
Task	Date Completed	Date Completed	Result
Disinfect Bottles			
Drain Check			
Nozzle Cleaning			

- 2 Press **Record Maintenance**.

PM Task entry options:

- QC Slide Staining (Drop Down Menu)
  - Not Completed
  - Acceptable
  - Unacceptable
  - Inconclusive
- Disinfect Reusable Bottles
  - Completed (Select/Deselect)
- Drain Check
  - Completed (Select/Deselect)
- Manual Nozzle Cleaning
  - Completed (Select/Deselect)

- 3 Press **Save** to record entries.



## SECTION 5 PREVENTIVE MAINTENANCE AND SAFETY

### ***5.2 Storing the Instrument***

If the instrument is inactive for more than one week, you may want to perform the long-term storage procedure. This will prevent nozzles from clogging when the machine is reactivated.

#### **Preparing for Long-Term Storage**

- 1 With the carousel removed, remove and clean the nozzles. Store parts in tubes that are labeled to indicate their correct position.
- 2 Unscrew the cap and remove the dip tube from the bottles.
- 3 Place the end of the dip tube in a bottle of methanol.
- 4 Flush at least 250 mL of methanol through each reagent line by priming all lines simultaneously. Leave the alcohol in the line.



**CAUTION:**

Leave methanol in the reagent lines during storage. Allowing reagent lines to run dry can damage the instrument.



**CAUTION:**

Do not subject the instrument to freezing temperatures. Freezing of aqueous fluids in the lines may cause damage to the instrument.

- 5 Flush the bowl with water.
- 6 Return nozzles to their original positions.

#### **Preparing for Operation after Storage**

Follow the Setup and Preparation for Operation instructions (Section 2).

## SECTION 5 PREVENTIVE MAINTENANCE AND SAFETY

### ***5.3 Replacing Fuses***



**WARNING!**

To prevent the risk of fire, the main fuses should only be replaced with fuses of the same type and rating. Recurring fuse failure indicates serious internal problems, if this occurs, contact ELITechGroup.

- 1 Power **OFF** the instrument.
- 2 Disconnect the power cord from the power outlet and the rear panel of the instrument.
- 3 Open the fuse cover by inserting a screwdriver in the slot on the right side of the cover and gently prying the cover open.
- 4 Remove the fuse holders to inspect the fuses.
- 5 Replace the fuses if necessary.
- 6 Push the fuse holders in.
- 7 Close the fuse cover.
- 8 Reconnect the main power cord to the rear panel of the instrument and to the power outlet.
- 9 Power **ON** the instrument.



## SECTION 5 PREVENTIVE MAINTENANCE AND SAFETY

### ***5.4 Cleaning the Stainer and Carousels***



#### **WARNING!**

All cleaning procedures should be performed in a well-ventilated room by authorized and trained personnel wearing appropriate protection equipment.

- 1 Clean the outside of the instrument with 70 to 100% ethanol or methanol.
- 2 Clean the carousel and lid with 70 to 100% ethanol or methanol.

*NOTE: Freshly prepared (< 24 hours old) 10% bleach solution can be used as well. The 10% bleach solution helps clean the stained areas.*

#### **Cleaning Liquid Spills**

Remove any liquid spilled on the instrument immediately to avoid damage to the equipment.



#### **WARNING!**

**If potentially infectious liquid is spilled on the instrument, the instrument must be disinfected in accordance with all applicable local regulations. Refer to Decontaminating the Stainer and Carousels (Section 5.5) for instructions.**

#### **Cleaning Broken Slides**

You must take stringent precautions if a slide breaks inside the instrument during a staining cycle, especially if the instrument has been processing dangerous specimens. Always use protective gloves, safety glasses, and forceps when removing broken glass from inside the instrument.

- Glass shards embedded in the walls of the bowl can cause serious cuts and pose a risk of infection.
- Always remove embedded shards with a scraper before attempting to remove loose glass.
- Use a vacuum or adhesive tape to pick up loose glass inside the stainer bowl.

## SECTION 5 PREVENTIVE MAINTENANCE AND SAFETY

### ***5.5 Decontaminating the Stainer and Carousels***

All parts of the instrument that come into contact with biological specimens, patient specimens, positive control specimens, or hazardous material must be treated as potentially infectious.

Before the instrument is returned for service, all outer surfaces must be decontaminated. The operating authority must complete a disinfection declaration, otherwise the instrument may be rejected by the distributor or service center or quarantined by customs authorities.



**WARNING!**

Reagents used with the instrument contain moderately hazardous chemicals that require care in handling. Always use appropriate safety measures including gloves and eye protection, when handling reagents.



**WARNING!**

Authorized and trained personnel wearing appropriate protection equipment should perform the decontamination procedure in a well-ventilated room. It is very important to thoroughly decontaminate the instrument before removing it from the laboratory or before performing any technical service. This procedure may not be effective against prions.



**WARNING!**

Prior to decontaminating, disconnect the instrument from the main power supply to avoid any risk of fire or explosion.



**WARNING!**

The decontamination procedure and the disinfectants must comply with the local applicable regulations.

#### **Solutions for Decontaminating the Instrument**

The outer surfaces of the instrument should be decontaminated using a decontaminating solution such as:

- 70% ethanol or methanol
- Mild detergent
- 10% bleach solution (< 24 hours old)
- Decontamination Solution (REF: SS-133)

SECTION 5  
PREVENTIVE MAINTENANCE AND SAFETY

**5.5 Decontaminating the Stainer and Carousels**

**Figure 12: Lid Latch and Locking Pin Hole Locations**



**Decontaminating the Instrument**

- 1 Prepare a suitable container for all disposables.
- 2 Cover the lid latch and locking-pin holes with waterproof tape to protect the interior (Figure 12).
- 3 Place the instrument in a biological safety hood or well-ventilated area.
- 4 Spray the inner bowl and inner lid with a decontaminating solution such as REF: SS-133.
- 5 Repeat the spray treatment every 2 or 3 minutes for a total of 20 minutes. Do not allow cleaning solutions to dry on the instrument surfaces.
- 6 Rinse the inner bowl and lid thoroughly with water.
- 7 Spray and wipe the exterior surfaces with decontamination solution such as REF: SS-133.



**CAUTION:**

Do not flood the display panel with excessive moisture. Any moisture that seeps through could damage the internal electronics.

## SECTION 5 PREVENTIVE MAINTENANCE AND SAFETY

### ***5.5 Decontaminating the Stainer and Carousels***

#### **Decontaminating the Instrument (continued)**

- 8 Repeat the spray treatment of exterior surfaces every 2 or 3 minutes for a total of 20 minutes. Do not allow cleaning/decontamination solutions to dry on the instrument surfaces.
  
- 9 Wipe surfaces thoroughly with a cloth soaked in water until you have removed all decontamination solution.
  
- 10 Immerse or generously spray the carousel and lid with decontaminating solution. Allow the solution to react for 20 minutes.
  
- 11 Thoroughly rinse the carousel and lid with deionized or distilled water.

#### **Decontaminating Reagent Bottles**

Any reused reagent bottles should be disinfected at each reagent lot change, or monthly:

- 1 Fill the reagent bottle with a fresh (< 24 hours old) 10% bleach solution.
  
- 2 Allow the bleach solution to react in the bottle for 10 minutes.
  
- 3 Rinse the bottle thoroughly with tap water.
  
- 4 Rinse the bottle thoroughly with deionized or distilled water.

SECTION 5  
PREVENTIVE MAINTENANCE AND SAFETY

**5.6 Shipping or Disposing of the Stainer or Carousels**

**Shipping the Instrument or Carousels**



**WARNING!**

You must disinfect the instrument or carousels before returning it to ELITechGroup. The operating authority must complete a Hazard-Free Certification form, otherwise the distributor or service center may not accept the instrument; or customs authorities may hold it.



**CAUTION:**

Shipping the instrument or carousels without decontaminating according to these instructions is dangerous to service personnel. You will be charged additional fees for decontamination performed by ELITechGroup.



**CAUTION:**

Ship the instrument or carousels in containers comparable to the original packaging.

**Hazard-Free Certification**

The operating authority must print and complete the Hazard-Free Certification (obtained from ELITechGroup Customer Service).

Attach the certification form to the top of the instrument package before sending the package to ELITechGroup.

**Disposing of the Instrument or Carousels**

The instrument and carousels should be completely decontaminated and disposed of as follows:



Under WEEE Directive 2012/19/EU , this equipment cannot be disposed of in a municipal landfill. Instead, the equipment must be disposed of either by:

- 1 Routing to an authorized local facility approved for handling hazardous materials.

OR

- 2 Returning the equipment to ELITechGroup or an authorized distributor.

## SECTION 6 NOZZLE MAINTENANCE AND PERFORMANCE

### 6.1 Nozzle Disassembly and Cleaning

Nozzle maintenance requires the Nozzle Maintenance Kit and prepared Nozzle Cleaning Solution (diluted REF: SS-029C).



#### **WARNING!**

**Always wear protective clothing and eye protection when using Nozzle Cleaning Solution (SS-029 or diluted SS-029C). Dispose of used solution properly.**

**NOTE:** *If the compression screw cannot be easily loosened, use light penetrating oil and a 5/8-in. wrench to loosen the nozzle.*

#### **Nozzle Disassembly**

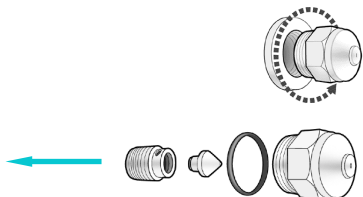

- 1 Remove the nozzle using the nozzle tool from the Nozzle Maintenance Kit.

- 2 Disassemble the nozzle. See Figure 5: Nozzle Diagram in Section 1.

- 3 If you will be storing the nozzle parts in Nozzle Cleaning solution longer than one hour, remove the o-ring.

- 4 Place the nozzle parts (minus the o-ring if required) in a 50 mL conical tube that has been clearly marked with the correct nozzle position.

**Note:** *Do not mix or interchange nozzles or nozzle parts. Always return nozzles to same location in stainer.*

- 5 Repeat Steps 1 through 4 for each nozzle.

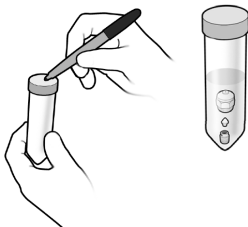

#### **Nozzle Cleaning**

- 1 Fill each 50 mL tube with 25 mL of prepared Nozzle Cleaning Solution (REF: SS-029C) and cap the tube.



- 2 Gently invert the tube at least ten times to ensure all parts come in contact with the cleaning solution.

- 3 Place the tube in the correctly marked position in the provided tube stand. Soak the parts as long as possible.

**NOTE:** *Soak nozzle parts for at least 15 minutes. Parts can be soaked in Nozzle Cleaning Solution overnight.*

- 4 Repeat steps 1 through 3 for each nozzle.

## SECTION 6 NOZZLE MAINTENANCE AND PERFORMANCE

### 6.2 Nozzle Reassembly

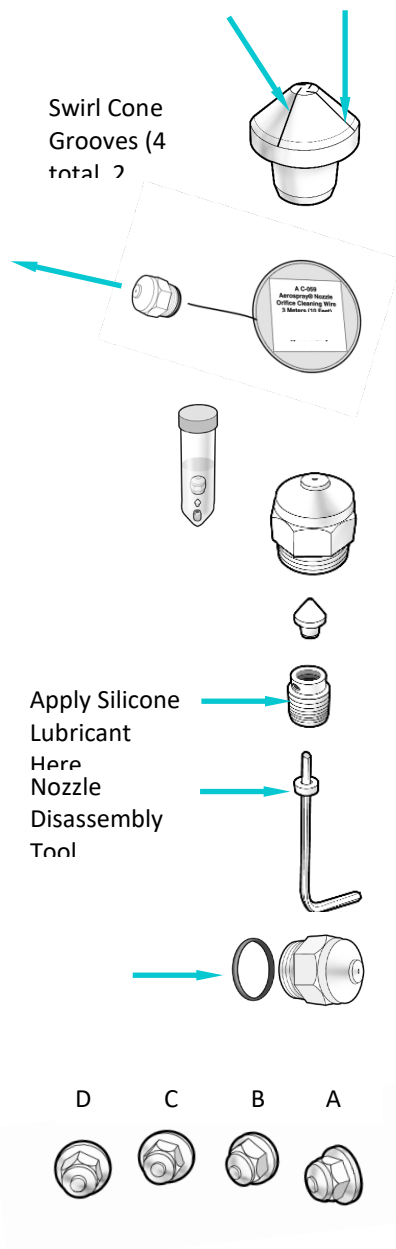

- 1 Hold your thumb or a nozzle strainer over the end of the tube to keep the nozzle parts in the tube. Discard the cleaning solution according to applicable statutes.
  - 2 Inspect the nozzle parts. Remove any material in the swirl cone grooves by sliding a piece of paper edgewise along each of the 4 grooves.
  - 3 Thread the nozzle orifice cleaning wire (REF: AC-059) through the back of the disassembled nozzle housing.
  - 4 Place the nozzle parts back into the tube and rinse them with water.
  - 5 Rinse the parts again with alcohol.
  - 6 Apply a small amount of silicone lubricant (REF: AC-103) to the compression screw threads.
  - 7 Reassemble the nozzle by placing the compression screw on the nozzle disassembly tool, then inserting the swirl cone into the compression screw.
- NOTE:** Hold all the parts in a vertical position during reassembly.
- 8 Reinstall the nozzle housing over the swirl cone and compression screw.
  - 9 Replace the o-ring if it was removed earlier.
  - 10 Return the assembled nozzle to its original position in the instrument.
  - 11 Repeat Steps 1 through 10 for each nozzle.
  - 12 Perform a Hub Pattern Test (Section 4.1) and a Volume Test (Section 6.4).
- NOTE:** You must perform the Hub Pattern Test and Volume Test before operating the instrument. If the results are incorrect, manually prime the instrument.

**NOTE:** If staining will not be performed immediately run a clean cycle after Volume and Hub Pattern tests.

## SECTION 6 NOZZLE MAINTENANCE AND PERFORMANCE

### 6.3 Manual Priming

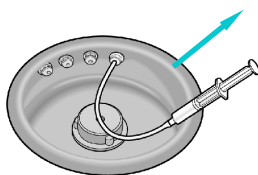

- 1 Remove the carousel from the bowl.
- 2 Remove the nozzle connected to the line to be manually primed.
- 3 Insert the priming tool nozzle adapter (included in the Nozzle Maintenance Kit) into the nozzle holder and turn it clockwise to install the adapter into the holder.
- 4 Withdraw the priming tool plunger halfway to create a vacuum. Hold the plunger in that position.
- 5 Press **Maintenance** from the Main menu.
- 6 Press **Volume Test**.
- 7 Press the desired prime button to start the reagent pump.
- 8 Run the reagent into the tube until the fluid is free of bubbles, then press **Stop**.



#### **WARNING!**

**Do not pull the plunger completely out of the priming tool. Pulling the plunger out of the tool may result in splashing or spraying of reagents. Do not push the plunger in while it is connected to the nozzle holder.**



- 9 Turn the nozzle adapter counterclockwise to remove it from the nozzle holder.
- 10 Discard the collected fluid into the stainer bowl.
- 11 Reinstall the nozzle.
- 12 Perform a Hub Pattern Test.
- 13 Perform a Volume Test.

**NOTE:** *If staining will not be performed immediately run a clean cycle after Volume and Hub Pattern tests.*



## SECTION 6

### NOZZLE MAINTENANCE AND PERFORMANCE

#### **6.4 Performing the Volume Test**

The Volume Test requires the Nozzle Maintenance Kit.

**NOTE:** The Volume Test must be performed weekly. If staining will not be performed immediately run a clean cycle after Volume test.



- 1 From the Maintenance menu, select **Volume Test**.
- 2 Hold a Volume Test tube (small tube) to cover the selected nozzle.
- 3 Press the corresponding reagent prime button to collect the reagent.

**NOTE:** With QC/Maintenance tracking enabled, enter the measured volume on the keypad and press ENTER. With QC/Maintenance Tracking disabled, the menu returns to the Maintenance menu.



- 4 Remove and cap the tube.
- 5 Record the nozzle position on the tube and place the tube in the appropriate position in the tube stand.
- 6 Repeat Steps 2 through 5 for each nozzle.
- 7 Compare collected nozzle volumes with the following table.

**Table 12: Volume Test Tolerances**

Nozzle/Reagent Line	Minimum	Maximum
A, B, C	9.0 mL	11.0 mL
D	8.5 mL	10.5 mL

**NOTE:** The stainer normally functions correctly if nozzle volumes are slightly higher or lower than the specified range. It is important that the B and C nozzle volumes are similar, (typically within 1 mL). Spray volumes < 7.5 mL or > 13.0 mL indicate serious problems with the nozzles or reagent delivery lines.

- If the volume is within the tolerance range, go to Step 8.
- If the volume is outside the tolerance range:
  - a. Clear the nozzle orifice with the nozzle brush found in the maintenance kit.
  - b. If necessary, remove the nozzle and perform the Nozzle Cleaning procedure (Section 6.1).
  - c. If the problem persists, replace the nozzle.



**NOTE:** If the problem persists after you have replaced the nozzle, contact ELITechGroup.

## SECTION 6 NOZZLE MAINTENANCE AND PERFORMANCE

### ***6.4 Performing the Volume Test***

- 8 Prepare the Maintenance Kit for future use:
  - Empty the contents of the tubes into the stainer bowl.
  - Rinse the tubes with water.
  - Put the tubes back into their original place in the Maintenance Kit or tube stand.
  
- 9 Press **Back** twice to return to the Main menu.

## SECTION 6 NOZZLE MAINTENANCE AND PERFORMANCE

### 6.5 Performing the Slide Pattern Test

This test can differentiate poor staining results from sample preparation problems, or nozzle obstructions. Perform the Slide Pattern test when a Hub Pattern test produces a normal result, but staining is still inadequate.

- 1 Place a 1 x 3 inch (2.5 x 7.6 cm) piece of paper (REF: RP-500) in positions 1 and 2 of the carousel, with a blocking slide in front of positions 1 and 2.
- 2 Load the carousel into the stainer and close the lid.
- 3 From the Main menu, press **Maintenance**.
- 4 Press **Pattern Test**.
- 5 Press the corresponding prime button for the reagent line to be tested.
- 6 Remove the paper slides.
- 7 Repeat Steps 1 through 6 for each reagent line.
- 8 Examine the paper slides for each reagent. The pattern on the slide should be uniform, without any continuous lines or streaks.



**Figure 13: Correct Slide Pattern Test Result**

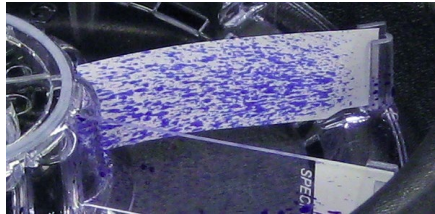

**Figure 14: Incorrect Slide Pattern Test Result**

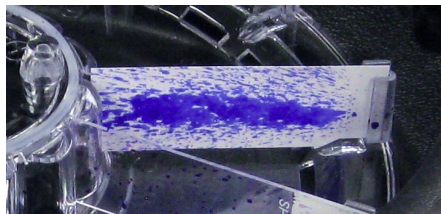

- 9 If the result is incorrect, clear the nozzle blockage using the nozzle brush, or disassemble and clean the nozzle (Section 6.1).

**NOTE:** If staining will not be performed immediately run a clean cycle after Volume and Hub Pattern tests.

## SECTION 7 SOLVING PROBLEMS

### 7.1 Troubleshooting

The following table is to help identify and solve routine problems with the stainer. More difficult problems may require technical service. Contact your ELITechGroup representative for assistance.



#### **WARNING!**

**Due to the electrical shock hazard, do not open this instrument or attempt internal repairs. Refer servicing to qualified service personnel. Contact your dealer or ELITechGroup Service.**

**Table 13: General Troubleshooting and Diagnosis**

<b>Problem</b>	<b>Solution</b>
There is no power to the stainer when the power switch is turned ON.	Check the facility outlet and the power cord connection. Check the fuses. Refer to the Replacing Fuses procedure. <b>⚠ CAUTION:</b> Fuse failure may indicate a serious internal problem.
Strange information shows on the display, and/or erratic stainer operation.	Switch the power <b>OFF</b> , wait 10 to 20 seconds, then switch power <b>ON</b> again. If problem recurs, install a computer-type surge suppressor to protect the instrument from power line transients. If possible, connect the stainer to a power circuit that is not shared by centrifuges, refrigerators, air conditioners, or other motorized equipment.  If the above steps do not solve the problem, consult the Aerospray Service Manual, or contact your dealer or ELITechGroup for assistance.
A reagent line will not prime when power is ON and you press the prime button.	Follow the procedures in Section 6.3 for priming reagent pumps.
A reagent line will not prime, even with the priming tool (Section 6.3).	Press the priming button and listen carefully for the sound of the pump. If you can hear the pump, try the priming tool again. If the problem is not solved or if you cannot hear the pump there may be an internal problem. Contact your dealer or ELITechGroup for assistance.
Stainer bowl fills with reagent after use.	A small puddle of stain around the drain inlet or the bottom of the bowl is normal. If the bowl is filling with a large quantity of stain, check the external drain tube for blockage. Make sure the drain tube is properly connected and running continuously down toward the lab drain or vented waste container, with no loops, rises, or obstructions. Make sure the end of the tube is not submerged. This can prevent proper drainage. The internal drain may need to be cleaned or replaced. See the Aerospray Service Manual, or contact your dealer or ELITechGroup Service.

SECTION 7  
SOLVING PROBLEMS

**7.1 Troubleshooting**

**Table 13: General Troubleshooting and Diagnosis (continued)**

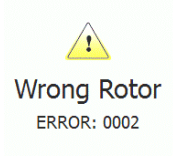
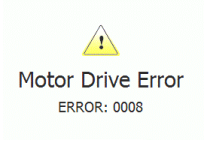
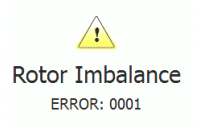
Problem	Solution
<p>Stain is leaking onto the counter.</p>	<p>Check all external reagent lines for visible signs of cracks or loose fittings.</p> <p>Make sure the drain outlet is not blocked.</p> <p>Make sure the drain tube is securely attached to the drain port and that the tubing is not cracked or deformed.</p> <p>Reagent leaks may indicate an internal problem (see Section 7.3). See the Aerospray Service Manual, or contact your dealer or ELITechGroup for further assistance.</p>
<p>Error messages on the screen.</p> <div style="text-align: center; margin: 10px 0;">  </div> <div style="text-align: center; margin: 10px 0;">  </div> <div style="text-align: center; margin: 10px 0;">  </div>	<p>If the display shows Lid Not Shut: Verify that the lid is fully closed and latched. If the Lid Not Shut indication remains, contact ELITechGroup for assistance.</p> <p>If the display shows Wrong Rotor after pressing Start: Make sure the slide carousel is properly loaded on the drive hub. In staining mode, the instrument detects whether the staining carousel is present before proceeding. In cytocentrifuge mode, the instrument will stop if it senses the staining carousel. After verifying the carousel is correctly loaded, press <b>Start</b>. If the display still shows Wrong Rotor, there may be an internal problem. Check for missing carousel magnets.</p> <p>The microprocessor monitors carousel rotation during a staining cycle. The display shows an error message if the rotation is not within the specified range.</p> <p>If the display shows Motor Drive Error: Check the stainer bowl for interference: Turn the hub or carousel by hand; it should turn freely.</p> <p>Drive motor or electronic component malfunctions require servicing of internal components. Contact your dealer or ELITechGroup for assistance.</p> <p>If the display shows Rotor Imbalance, make certain the Cytopro rotor is balanced, or the staining carousel is seated correctly on the hub.</p> <p>See Electronic Failure later in this table.</p>

SECTION 7  
SOLVING PROBLEMS

**7.1 Troubleshooting**

**Table 13: General Troubleshooting and Diagnosis (continued)**

Problem	Solution
<p>The stainer fails to spray reagent during a staining cycle and/or continues to run after the cycle should be complete.</p>	<p>To allow programmed staining of partial loads, the stainer monitors the position of the carousel as it rotates in the bowl. In normal operation, stain is sprayed only in the correct position. This causes the actual cycle time to vary, depending on the position of the carousel at the beginning of the cycle. However, if the cycle continues for an abnormally long period, or if the bar graph and percentage complete icon do not change after 1 minute, it may indicate an electronic problem or an internal problem. To determine this, press <b>Stop</b>.</p> <p>If the cycle stops: this indicates a problem with the carousel position sensor. Consult the Aerospray Service Manual, or contact your dealer or ELITechGroup for assistance.</p> <p>If the cycle continues: this indicates an electronic problem (see below).</p>
<p>Abnormal staining on entire surface of all slides.</p>	<p>Check the reagent level on the display and/or in the reagent bottles.</p> <p>Make sure the external reagent dip tubes are securely attached to each bottle (Section 2.1).</p> <p>Open the lid and verify that each reagent pump is primed, by pressing the corresponding prime button. The nozzle should immediately spray a fine mist of reagent. There should be no sputtering or hissing sounds indicating air in the reagent lines.</p> <p>Watch the external tubes for air bubbles. Air bubbles indicate inadequate priming or possibly an air or reagent leak in the system. Air in any reagent line will cause poor staining.</p> <p>Check nozzle performance using the Slide Pattern (Section 6.5) and Volume Tests (Section 6.4). If necessary, clean nozzle(s) using the procedures in Section 6.1.</p> <p>Verify that each reagent dip tube vent hole is clear.</p>

SECTION 7  
SOLVING PROBLEMS

**7.1 Troubleshooting**

**Table 13: General Troubleshooting and Diagnosis (continued)**

<b>Problem</b>	<b>Solution</b>
Abnormal staining on entire surface of all slides (continued).	<p>When staining a full carousel (7 or more slides) make certain you have not programmed the stainer for fewer slides.</p> <p>If staining a partial load, load the slides in the correct positions as indicated by the markings on the carousel (see Section 4.1).</p>
Abnormal staining on entire surface of some slides, while other slides from the same carousel appear normal.	<p>Make certain that all position magnets are still attached to the bottom of the carousel. Make certain you have not programmed the stainer for fewer slides than you have loaded.</p> <p>If you program the stainer for a partial load, load the slides in the correct positions as indicated by the markings on the carousel (see Section 4.1).</p> <p>Verify that each reagent pump is primed by opening the lid and pressing the corresponding prime button. The nozzle should immediately spray a fine mist of reagent. There should be no sputtering or hissing sounds to indicate the presence of air in the reagent lines (see Section 7.3).</p>
Streaks or bands of discoloration on one or more slides.	<p>Check the level of the Rinse (Reagent A) bottle. Check Rinse (Reagent A) spray volume according to Section 6.4.</p> <p>Check nozzle spray pattern according to the procedures in Sections 4.1 and 6.5. This type of discoloration is usually caused by debris or reagent precipitate clogging the spray nozzle orifice.</p> <p>Clean any nozzle that exhibits a poor spray pattern.</p>
Cells are washing off slides.	<p>Check methanol or Aerofix (Reagent D) level in bottle.</p> <p>Check Reagent D nozzle spray volume and slide pattern (see Section 6.4 and Section 6.5).</p>

SECTION 7  
SOLVING PROBLEMS

**7.1 Troubleshooting**

**Table 13: General Troubleshooting and Diagnosis (continued)**

<b>Problem</b>	<b>Solution</b>
Cells are washing off slides (continued).	Check the methanol or Aerofix (Reagent D) hub pattern and spray volume (see Sections 4.1 and 6.5). Make certain the blood smears are completely dry and not too thick (see Section 7.2). Increase the fixation setting to High.  Call ELITechGroup for information on slide quality.
Refractile artifacts are observed in erythrocytes.	Use Aerofix (SS-048 or SS-148) fixative. Refer to Section 7.2.
High levels of precipitates observed.	Discard leftover thiazin stain (Reagent B) in the used bottle when changing to a fresh bottle of stain. While transferring remaining stain saves stain, it eventually concentrates the precipitates to the point they appear on the slide.
Staining intensity is too weak. Granulation is weak.	Increase the intensity setting.
Refractile artifacts are observed in erythrocytes when using Basofix predip (SS-049P).	Mix 1 part Aerofix (SS-048) with 3 parts Basofix predip (SS-049P), or add 5 mL Aerofix concentrate (SS-148) to 500 mL Basofix predip (SS-049P).
Increased false-positives for Howell-Jolly bodies or amorphous precipitates are observed.	Disinfect reagent lines using instructions in Section 7.2.  Discard leftover thiazin stain (Reagent B) in the used bottle when changing to a fresh bottle of stain. While transferring remaining stain saves stain, it eventually concentrates the precipitates to the point where they can be seen on the slide.



SECTION 7  
SOLVING PROBLEMS

**7.1 Troubleshooting**

**Table 13: General Troubleshooting and Diagnosis (continued)**

Problem	Solution
Electronic Failure	<p>An electronic failure would appear as an obvious malfunction such as a scrambled or totally inoperative display panel.</p> <p>Transient voltages coming through the power lines may cause the stainer to “lose its place.”</p> <ol style="list-style-type: none"> <li>1 If this occurs, switch the main power OFF for 10-20 seconds and then back ON to reset the instrument.</li> <li>2 If the problem recurs, install a computer-type surge protector to isolate the instrument.</li> <li>3 If possible, connect the stainer to a power circuit not shared by centrifuges, refrigerators, air conditioners, or other motorized equipment.</li> </ol> <p>For more obscure electronic problems, monitor the stainer through a complete staining cycle to determine if the operating sequence is correct. Do this by running the stainer while watching the display and listening to the pumps.</p> <p>Ensure that each event occurs according to the operating sequence, shown in Table 3 in Section 1.</p> <p>If the problem recurs, contact your dealer or ELITechGroup for assistance.</p>

## SECTION 7 SOLVING PROBLEMS

### 7.2 Abnormal Staining Results

#### Smear Separation or Tearing

Losing blood cells from the slide surface during a staining cycle can happen for several reasons:

##### Improper Alcohol Fixation

If the alcohol-fix phase of the cycle fails, there will be cell loss when stain is applied. Verify that the alcohol nozzle is operating properly with normal spray pattern and spray volume (Sections 6.4, 6.5). To identify the problem as a fixation failure, fix some specimen slides in methanol prior to loading into the carousel. Select a fixation setting that increases fixation (7, 8, or 9).

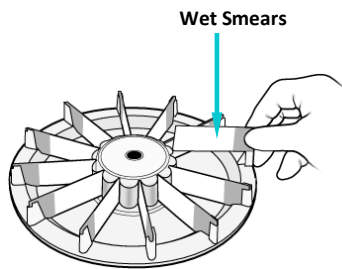

##### Wet Smears

Loading wet blood smears into the carousel may contribute to smear tearing. Allow smears to dry for several minutes before beginning a stain cycle.

##### Thick Smears

Smears that are too thick can cause smear separation. If the smear has a thick “wedge” cross section, cells can be torn away from the slide surface in the thicker regions, while the thinner “monolayered” regions remain usable. Severe tearing that starts in the thick region may also extend into the monolayer.

##### Dirty Slides

Dirty slides are a major source of cell loss during staining. We strongly recommend that you use new, premium quality slides.

Even with premium quality slides, random loss may occur due to inadequate slide surface quality. When the stainer is functioning properly, slide quality accounts for most, if not all, cell loss problems.

##### Red Cell Artifacts

Refractile bodies or inclusions (seen as dark ringed objects on red cells) are thought to be caused by the presence of water during fixation. Often called “water spotting,” this effect is common in Romanowsky staining. Methanol used for fixation must be anhydrous (0.5% or less water).

Methanol that is exposed to the atmosphere will absorb a considerable amount of water, particularly when the relative humidity is high. The first line of defense to avoid water spotting is to make certain the methanol used for fixing smears is free of water. If in doubt, replace it with reagent known to be anhydrous.

## SECTION 7 SOLVING PROBLEMS

### **7.2 Abnormal Staining Results**

#### **Red Cell Artifacts (continued)**

When the relative humidity is above 60 percent, water spotting may be seen even when using anhydrous methanol for fixation. This occurs because of moisture accumulation and condensation inside the carousel chamber. Relative humidity within the chamber will tend to build up with repeated use, leading to further problems. If water spotting occurs:

#### **Use Aerofix®**

Water spotting can be eliminated by using Aerofix. Aerofix is available as an additive (REF: SS-148, 135 mL bottle, enough for nine 500 mL bottles of methanol) or premixed with methanol (REF: SS-048, 500 mL bottle).

- **Pre-fix Slides**

Water spotting can usually be eliminated by pre-fixing slides in anhydrous methanol before loading into the carousel. Allow the slides to dry for 2 to 3 minutes before staining.

- **Wipe Carousel Chamber Dry**

Between cycles, leave the stainer lid open to dry out the bowl. If necessary, wipe the interior of the carousel chamber dry to reduce the relative humidity. Or, irrigate the chamber with methanol from a wash bottle.

#### **False-Positive Howell-Jolly Bodies or Amorphous Precipitates**

Artifactual Howell-Jolly bodies can be caused by precipitate build up from transferring the residual thiazin stain (Reagent B) to the fresh bottle when reloading reagents. Such artifacts may also indicate microbial contamination of the reagent lines and pumps.

If such artifacts are encountered, and if you suspect microbial contamination, use the following solution to disinfect the reagent lines and pumps.

Replace precipitated stain with fresh stains after flushing the B line with the disinfecting solution.

#### **Disinfectant Solution:**

10% freshly prepared dilution of household bleach (5.25% Sodium Hypochlorite).

#### **Dilution:**

100 mL household bleach
+ 900 mL deionized water
<hr/>
= 1000 mL

## SECTION 7 SOLVING PROBLEMS

### 7.2 Abnormal Staining Results

Procedure:

**NOTE:** Do not remove the nozzles.

- 1 Pump 150 mL of prepared solution through each affected reagent line (A, B and C). Wait 20 minutes.
- 2 Pump another 100 mL of disinfectant solution through each affected reagent line and let sit for 20 minutes.
- 3 Flush each affected reagent line with 150 mL of deionized water.
- 4 Reprime the stainer with fresh reagents (see Section 2.2) and clean nozzles according to instructions in Section 6.1 and 6.2.
- 5 Perform a Volume Test according to instructions in Section 6.4 and record on PM Chart.



**CAUTION!**

To avoid damage to the instrument, do not leave disinfectant solution in the reagent lines longer than recommended. This procedure should only be performed on an “as needed” basis.

## SECTION 7 SOLVING PROBLEMS

### 7.3 Instrument Malfunction

#### Air or Reagent Leaks

Repriming the instrument is usually unnecessary unless a reagent bottle runs completely dry.

An air leak is usually to blame if a smooth and continuous liquid spray fails to come from the nozzles. Carefully inspect all components in the external reagent delivery lines. Look for loose connections, cracks, or breaks that might allow air to be drawn in when the pump operates. Replace any defective part or assembly.

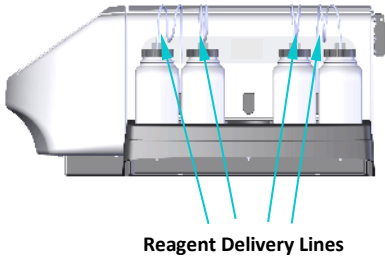

An internal leak may cause fluid to leak from the line when the pump is not running. If an abnormal liquid spray still occurs after all the external reagent delivery line components have been verified, the instrument may require service. Contact your dealer or ELITechGroup for assistance.

A reagent line leak between the pump outlet and the nozzle will cause fluid to leak into the interior of the stainer housing and ultimately onto the counter. If you observe this, the instrument will require service. Contact your dealer or ELITechGroup for assistance.



#### WARNING!

A break or malfunction in the reagent delivery system can potentially release up to 500 mL of highly flammable anhydrous alcohol in and around the instrument. If this occurs, carefully shut off the power to the instrument and consult the SDS for information in handling alcohol spills. Do not use the instrument again until any leaks are repaired.



#### WARNING!

Electrical shock hazard—do not open this instrument or attempt internal repairs. Refer servicing to qualified service personnel. Contact your dealer or ELITechGroup Service.

## SECTION 7 SOLVING PROBLEMS

### 7.3 Instrument Malfunction

#### Reagent Level Detect System Errors

##### Reagent A-D Not Calibrated

During the second part of calibration, if no bottles are detected, the display shows an error message.



Calibrate again, making sure that the reagent bottles are inserted in those tray positions that have been enabled in the level detection system.

##### Level Detection (LD) Unstable

If movement was detected on bottles while calibrating/zeroing, the display shows an error message.

##### NOTE:

*While zeroing or calibrating, do not bump the instrument or lab bench. Ensure that no nearby equipment vibrations can be transmitted to the stainer.*

#### Calibrating the Reagent Level Detect System

If the Reagent Level Detect System is reporting incorrectly and zeroing (Section 2.2) does not correct the problem, calibrate the system as follows:



1 Press **System Information** from the Main menu.



2 Press **System Setup**.



3 Press **Level Detect**.

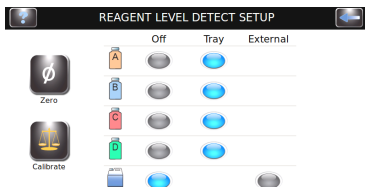

4 Press **Calibrate**. Follow the display prompts.



### 7.3 Instrument Malfunction

#### Calibrating the Reagent Level Detect System (continued)



- 5 Remove all reagent bottles and press **Start**.

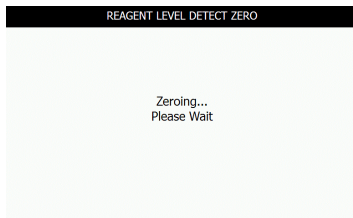

**NOTE:** Any vibrations or bumps to the instrument or lab bench can cause inaccuracies in zeroing or calibration.

**NOTE:** Calibration requires full, unopened (caps and seals in place) 500 mL bottles of reagent, placed in the correct tray positions (due to different densities of each reagent type).



- 6 Place the correct reagent bottles in all **enabled** positions, and press **Start**.

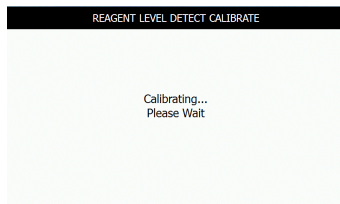

**NOTE:** The calibration function ignores any disabled reagent line.



- 7 Press **OK**. Press **Back** twice to return to the Main menu.

- 8 Return the reagent bottles to the tray as indicated in Section 2.1 to prepare for staining.

**NOTE:** For accurate reagent level detection and calibration, dip tubes must follow their pre-formed coiled shapes.

## SECTION 7 SOLVING PROBLEMS

### ***7.4 Calibrating the Touchscreen***



- 1 Press and hold **Standby/Ready** for 5 seconds. A calibration screen with a target appears.
- 2 Press the center of the target with a finger, stylus, or similar tool. Another target will appear in a different location.
- 3 Continue to press the center of the targets until you have pressed all the targets (five total). After the fifth target is pressed, the instrument will save the touch screen calibration and return to the Main menu.



## SECTION 7 SOLVING PROBLEMS

### **7.5 Service Information**

ELITechGroup's Service Department will help you resolve any questions about the operation or performance of your Aerospray Stainer/Cytocentrifuge.

Customers in the United States should contact us by telephone. Outside the U.S., our authorized dealers offer full local service and support.



**ELITechGroup Inc.**

370 West 1700 South  
Logan, Utah 84321 USA

**Telephone:**

800 453 2725 (*United States & Canada*)  
(+1) 435 752 6011 (*International calls*)

**Fax:**

(+1) 435 752 4127

**Email:**

Service\_EBS@elitechgroup.com (*Service*)  
Sales\_EBS@elitechgroup.com (*Sales*)

**Web Page:**

[www.elitechgroup.com](http://www.elitechgroup.com)

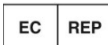

**European Authorized Representative:**

MT Promedt Consulting  
Ernst-Heckel-Straße 7  
66386 St. Ingbert  
Germany

Telephone: +49(0)68 94-58 10 20

Fax: +49(0)68 94-58 10 21

Email: [info@mt-procons.com](mailto:info@mt-procons.com)



**Swiss Authorized Representative:**

Decomplic AG  
Freiburgstrasse 3  
3010 Bern  
Switzerland  
Telephone: +41 32 365 33 33  
Email: [sar@decomplic.com](mailto:sar@decomplic.com)

## SECTION 8 CYTOPRO® CYTOCENTRIFUGE

### **8.1 Cytopro Cytocentrifuge Information**

#### **Functional Description**

The Cytopro Cytocentrifuge rotor allows rapid sedimentation of specimen cells onto microscope slides for staining or other purposes. Up to eight disposable/reusable sample chamber assemblies with absorbent pads and glass microscope slides can be loaded into the Cytocentrifuge rotor.

Cytocentrifuge and staining functions are independent of one another.

**The Cytopro rotor reduces cell loss during collection and prevents accidental damage to the collected specimen. The rotor is sealed to control aerosol release during cytocentrifugation.** See the Cytopro Rotor Applications Manual (Aerospray Models 7xx2) (RP-517) for complete information.

#### **Key Features**

Adding the Cytopro Cytocentrifuge rotor transforms the stainer into a standard cytocentrifuge with:

- Single, Dual, and Cytopro Magnum chambers
- Reusable or disposable chambers (single and dual)
- Eight slides and chambers
- User-programmable memory locations for settings (speed, acceleration rate, and time)
- Easy switching between staining and cytocentrifuge modes
- Autoclavable rotor

**NOTE:** Pressing *Cyto* brings up the *Cytocentrifuge* mode. Pressing *Back* returns to *stain* mode.



#### **WARNING!**

**The Cytopro rotor lid, rotor gaskets and related components are intended to be part of biosafety system as specified in international and national biosafety guidelines. They cannot be relied on as the only means of safeguarding workers and the environment when handling pathogenic microorganisms.**

#### **Cytopro® Rotor**

The Cytopro Cytocentrifuge rotor is an in vitro diagnostic medical device for professional use only. It is an accessory for fixing biological cell suspensions on glass microscope slides for cytological examination.

The Cytocentrifuge rotor can be used with the following cell suspensions:

- Bronchoalveolar liquid (BAL)
- Cerebrospinal fluid (CSF)
- Urine
- Synovial fluid
- Others

## APPENDIX A

### Critical Reagent Components



The following information identifies the critical chemicals of each reagent used in this instrument.

Reagent(s)	Critical Components
SS-035A, SS-035A-EU, SS-035AG, or SS-135/149A (as diluted) Hematology Reagent A Rinse contains:	<1% Potassium Phosphate <1% Sodium Phosphate <1% Eosin <1% Benzyl Alcohol
SS-035/049B, SS-035/049B-EU, SS-035/049BG, or SS-135/149B (as diluted) Hematology Reagent B Thiazin Stain contains:	<1% Potassium Phosphate <1% Sodium Phosphate <1% Azure B <1% Methylene Blue <1% Benzyl Alcohol <0.1% Tergitol TMN 100X
SS-035C, SS-035C-EU, SS-035CG, or SS-135/149C (as diluted) Hematology Reagent C Eosin Stain contains:	<1% Potassium Phosphate <1% Sodium Phosphate <1% Eosin <0.2% Formaldehyde <0.1% Tergitol TMN 100X
SS-048, or SS-148 (as diluted), SS-148-EU Aerofix Fixative High Humidity contains:	>95% Methyl Alcohol <4% Ethylene Glycol <2% Polyvinylpyrrolidone (PVP) <1% Azure B
SS-049A, SS-049A-EU, or SS-135/149A (as diluted) Basofix Reagent A contains:	<3% Ethyl Alcohol <3% Methyl Alcohol <1% Potassium Phosphate <1% Sodium Phosphate <1% Eosin < 0.2% Formalin
SS-049C, SS-049C-EU, or SS-135/149C (as diluted) Reagent C Basofix Eosin Stain contains:	<10% Diethylene Glycol <5% Ethyl Alcohol <5% Methyl Alcohol <1% Potassium Phosphate <1% Sodium Phosphate <1% Eosin Y
SS-049P, SS-049P-EU, or SS-149P (as diluted) Basofix Pre-dip Fixative contains:	<99% Methyl Alcohol <1% Polyvinylpyrrolidone <1% Azure B
SS-135/149A, Reagent A Rinse Reagent Concentrate contains:	<1% Potassium Phosphate <1% Sodium Phosphate <0.2% Formalin <1% Eosin
SS-135/149B, Reagent B Thiazin Stain Concentrate contains:	<10% Potassium Phosphate <10% Sodium Phosphate <2% Azure B <1% Methylene Blue

## APPENDIX A

### Critical Reagent Components

Reagent(s)	Critical Components
SS-135/149C, Reagent C Eosin Stain Concentrate contains:	<10% Potassium Phosphate <10% Sodium Phosphate <0.2% Formaldehyde <3% Eosin
SS-135S Surfactant contains:	<70% Germall II (Diazolidinyl Urea) <5% Tergitol TMN 100X
SS-148 or SS-148-EU, Aerofix Fixative Concentrate High Humidity contains:	55-70% Ethylene Glycol 30-45% Polyvinylpyrrolidone (PVP) <1% Azure B
SS-148 or SS-148-EU, Aerofix Fixative Concentrate High Humidity contains:	40-50% Methyl Alcohol 1-5% Oxalic Acid
SS-029, Nozzle Cleaning Solution Concentrate	40-55% Methanol 1-5% Oxalic Acid
SS-029C, Nozzle Cleaning Solution Concentrate contains:	95-99% Deionized Water 1-5% Oxalic Acid
SS-133 Decontamination Solution when diluted as directed contains:	<0-4% Germicidal Detergent >99% Deionized Water
SS-MeOH Anhydrous Methanol contains:	≥99.5% Methyl Alcohol, Anhydrous
SS-133 Decontamination Solution Concentrate contains:	<50% Germicidal Detergent >50% Deionized Water

## APPENDIX B

### Stain Information

#### Stain Description

The stains listed in this manual are for use with the Aerospray Hematology Stat Slide Stainer/Cytocentrifuge for use by medical professionals to stain specimens as a step of standard laboratory practice in diagnosing disease.

#### Stain Composition

Critical components of stains and cleaning solutions used with this instrument are listed in Appendix A.

#### Storage and Shelf Life

Stains and cleaning solutions are stable up to the expiration date indicated on the label.

Stains and cleaning solutions should be stored 15 – 30 °C unless otherwise stated on the label.

Once opened, stains are stable for 90 days on board the instrument.

#### Hazards and Precautions

The stains and cleaning solutions used with the Aerospray Hematology Stat Slide Stainer/Cytocentrifuge have been classified according to the following standards:

- Globally Harmonized System (GHS) United States Classification
- Regulation (EC) 1272/2008 Classification, Labelling and Packaging of Substances and Mixtures (CLP)

Information for each stain and cleaning solution regarding signal words, hazard classification, hazard pictograms, hazard and precautions statements can be found in the applicable Safety Data Sheet (SDS) for each stain or cleaning solution as well as the product labeling.

SDS for all stains and cleaning solutions can be requested from ELITechGroup technical service or can be obtained by accessing the following website:

<https://ebs.elitechgroup.com/SDS/>

## APPENDIX C

### ***Accessories and Supplies***

Only replacement parts supplied by ELITechGroup should be used in this instrument. Use of non-approved parts may affect the performance and safety features of this product.

<b>ACCESSORIES</b>	<b>REFERENCE NUMBER</b>
Slide Carousel (12-Slide Capacity) .....	AC-188
Cytopro Cytocentrifuge Rotor .....	AC-160
<b>STAINS AND CLEANING REAGENTS</b>	
Nozzle Cleaning Solution, 355 mL .....	SS-029
Nozzle Cleaning Solution Concentrate, 250 mL (Dilutes to 500 mL) .....	SS-029C or SS-029C-EU
Reagent A (Rinse), 500 mL.....	SS-035A or SS-035A-EU
Reagent B (Thiazin Stain), 500 mL .....	SS-035/049B or SS-035/049B-EU
Reagent C (Eosin Stain), 500 mL .....	SS-035C or SS-035C-EU
Reagent C (Eosin Stain), 3.785 L (1 gal) .....	SS-035CG
Reagent D (Methanol), 500 mL .....	SS-MEOH
Reagent A (Rinse), 3.785 L (1 gal) .....	SS-035AG
Reagent B (Thiazin Stain), 3.785 L (1 gal) .....	SS-035/049BG
Reagent A (Rinse) Concentrate, 135 mL (Dilutes to 4.6 L).....	SS-135/149A
Reagent B (Thiazin Stain) Concentrate, 135 mL (Dilutes to 4.6 L) .....	SS-135/149B
Reagent C (Eosin Stain) Concentrate, 135 mL (Dilutes to 4.6 L) .....	SS-135/149C
Surfactant (used with SS-135 A, B, C) .....	SS-135S
Reagent D (Aerofix® Fixative High Humidity), 500 mL .....	SS-048
Aerofix® Additive for Reagent D (Methanol), 135 mL .....	SS-148 or SS-148-EU
Reagent A (Basofix™ Rinse), 500 mL .....	SS-049A or SS-049A-EU
Reagent C (Basofix™ Eosin Stain), 500 mL.....	SS-049C or SS-049C-EU
Basofix™ Pre-dip Fixative, 500 mL .....	SS-049P or SS-049P-EU
Basofix™ Pre-dip Concentrate .....	SS-149P
Stain Residue Solvent .....	SS-230 or SS-230-EU
PM Cleaning Solution .....	SS-266 or SS-266-EU
<b>ADDITIONAL SUPPLIES</b>	
Nozzle Tool .....	AC-034
Nozzle Hex Wrench .....	AC-035
5 L Space-Saver Container w/cap (For Concentrate Reagents) .....	AC-038
Drain Tube, 1.8 meter (6 foot) Length.....	AC-041
500 mL bottle with cap (pack of 5 bottles).....	AC-043-05
Nozzle Orifice Cleaning Wire .....	AC-059
Reagent Pump Priming Tool .....	AC-069
Aerospray/Cytopro Safety Shield .....	AC-110
10 L Waste Container (without level detect).....	AC-170
1D Barcode Scanner .....	AC-181
10 L Waste Container (with level detect) .....	AC-182
Nozzle Maintenance Kit.....	AC-184
2D Barcode Scanner .....	AC-185
Decontamination Solution Concentrate.....	SS-133
O-Ring/Nozzle Thread Grease (3 grams) .....	SS-103
Preventive Maintenance Chart, pad of 24 sheets .....	SS-265
Aerospray Hematology Stat (Model 7122) Applications Manual .....	RP-460
Paper Test Slides.....	RP-500

## APPENDIX D

### Cleaning Solutions

ELITechGroup Inc. offers several cleaning solutions for the Aerospray Stainer/ Cytocentrifuge family. The following products are available to keep your Aerospray running safely and optimally.

#### **SS-029 and SS-029C/SS-029C-EU Aerospray® Nozzle Cleaning Solution**

Aerospray Nozzle Cleaning Solution (SS-029) and Aerospray Nozzle Cleaning Solution Concentrate (SS-029C/SS-029C-EU) when diluted as recommended should be used for cleaning the instrument. Specifically for:

- General cleaning
- Nozzle cleaning
- Instrument interior and exterior cleaning
- Carousel cleaning

The Aerospray Nozzle Cleaning Solution may be purged through the instrument pumps without causing damage to the instrument.

Dilution instructions for the Aerospray Nozzle Cleaning Solution Concentrate (SS-029C/SS-029C-EU) can be found by referring the instructions in **DOC-00123**.

#### **SS-133 Decontamination Solution Concentrate**

Decontamination Solution Concentrate (SS-133) when diluted as recommended should be used for decontamination of the inner and outer surfaces before the instrument is returned to ELITechGroup Inc. for Service or when instrument will be prepared for long-term storage.

#### **SS-222 Aerospray® Line Cleaner**

Aerospray Line Cleaner (SS-222) may be used if needed or if recommended by ELITechGroup Inc. service personnel to clean out the stainer lines.

Aerospray Line Cleaner can be purged through pumps without causing damage to the instrument.

Contact ELITechGroup technical service for more information.

## APPENDIX D Cleaning Solutions

### SS-230/SS-230-EU Aerospray® Stain Residue Solvent

The Aerospray Stain Residue Solvent (SS-230/SS-230-EU) is for exterior cleaning of the nozzles, carousels, and bowls of Aerospray Slide Stainers. The Aerospray Stain Residue Solvent can be used as a cosmetic cleaner for the outside of the instrument, sinks, floors, counter tops, etc.



#### **WARNING!**

**Do not run Aerospray Stain Residue Solvent (SS-230/SS-230-EU) through stainer pumps as serious damage will result to the instrument. This solvent is for the exterior cleaning of nozzles, carousels and bowls for Aerospray slide stainers only.**

#### **Cleaning Carousels**

1. Remove carousel from instrument.
2. Remove lid.
3. Pour a small amount of SS-230 Aerospray Stain Residue Solvent (~5-10 ml) on the carousel and the lid.
4. Lightly scrub the carousel with a paper towel or brush over all fouled areas. Rinse lid and carousel with water, methanol, and/or spray the top of the lid and run a carousel clean cycle.
5. Repeat as necessary.

#### **All other Cleaning**

1. Test the use of SS-230 Aerospray Stain Residue Solvent on a small non-conspicuous area of the surface to be cleaned to ensure compatibility.
2. Lightly scrub area to be cleaned with a paper towel.
3. Rinse the area cleaned with deionized water or methanol and wipe dry.

### SS-266/SS-266-EU Aerospray® PM Cleaning Solution

Aerospray PM Cleaning Solution (SS-266/SS-266-EU) can be used for cleaning the instrument when performing preventive maintenance on the instrument. The Aerospray PM Cleaning Solution is recommended for nozzle cleaning especially for nozzles that have stubborn contamination.

The Aerospray PM Cleaning Solution may be purged through the instrument pumps without causing damage to the instrument.

See Section 5 of this manual for information on preventive maintenance procedures.

### SS-MeOH Aerospray® Reagent Grade Methanol

Aerospray Reagent Grade Methanol (SS-MeOH) can be used for general exterior and internal cleaning of the instrument and pumps. Refer to the relevant sections in this manual for its applicable use.



ELITechGroup Inc.  
370 West 1700 South  
Logan, Utah 84321  
USA  
800 453 2725  
+1 435 752 6011

[WWW.ELITECHGROUP.COM](http://WWW.ELITECHGROUP.COM)